

# nova

AX1800/AX3000 Whole Home Mesh Wi-Fi 6 System

MX6/EX6/MX12/EX12

2-pack, 3-pack

Quick Installation Guide

***Tenda***

# Package contents

## MX6 (3-pack) & EX6 (3-pack)

### MX12 (3-pack) & EX12 (3-pack)

- Mesh6X/Mesh12X x 3
- Power adapters x 3
- Ethernet cable x 1
- Quick installation guide x 1

## MX6 (2-pack) & EX6 (2-pack)

### MX12 (2-pack) & EX12 (2-pack)

- Mesh6X/Mesh12X x 2
- Power adapters x 2
- Ethernet cable x 1
- Quick installation guide x 1

# Appearance

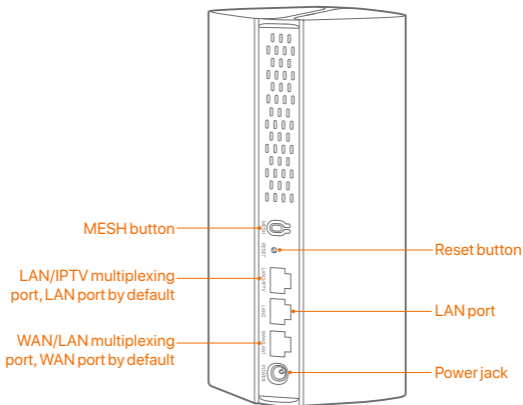

Button	Description
MESH	<p>MESH button.</p> <ul style="list-style-type: none"> <li>- As a networking button: Press this button on this device for about 1 to 3 seconds. The LED indicator blinks green fast, which indicates the device is searching for another device to form a network. Within 2 minutes, press the <b>MESH</b> button of another device for 1 to 3 seconds to negotiate with this device.</li> <li>- As a de-networking button: Press this button for about 8 seconds and release it when the LED indicator blinks red fast. The node is restored to factory settings, and also removed from the network and no longer automatically joins in again.</li> </ul> <p> <b>Tips</b> Do not hold down the <b>MESH</b> button for 8 seconds if unnecessary.</p>
RESET	<p>Reset button.</p> <p>When the device completes startup, hold down this button using a needle-like item (such as a pin) for about 8 seconds, and then release it when the LED indicator blinks red fast. The device is reset successfully.</p>

# 1 Connect the primary node

\*Choose one device from the kit to connect to the internet as the primary node in the network.



## Tips

If you do not use a modem for internet access, please skip steps 1 and 3.

1. Power off your modem.
2. Use the included Ethernet cable to connect the **WAN/LAN1** port to your modem or the Ethernet jack.
3. Power on your modem.
4. Power on the primary node, and wait until the LED indicator blinks green.

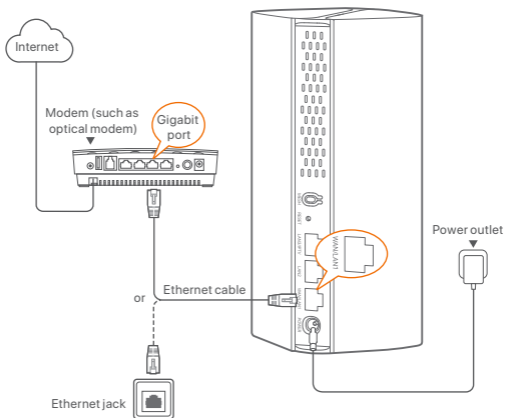

# 1 Connect the primary node to the internet

## Method 1: Setup through Tenda WiFi App

1. Download the **Tenda WiFi** App onto your mobile device by searching for **Tenda WiFi** in **Google Play** or **App Store** or by scanning the **QR** code. Then install the **Tenda WiFi** App.



OR



Tenda WiFi

2. Connect the mobile phone to the WiFi network of the primary node. The SSID and password can be found on the bottom label of the device.

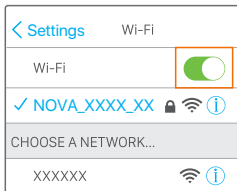

3. Run the **Tenda WiFi** App and follow the onscreen instructions to connect the device to the internet. After the device is connected to the internet, its LED indicator lights solid green, and the device has become the primary node in the network.

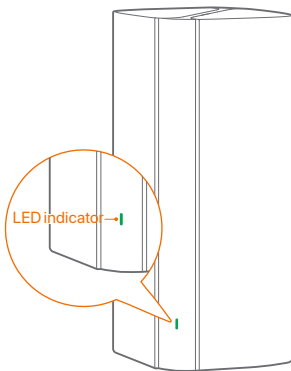

## Method 2: Setup through web UI

### 1. Connect the client to the primary node.

Method 1: Connect the wireless client such as a mobile phone to the WiFi network of the primary node. The SSID and password can be found on the bottom label of the device.

Method 2: Use an Ethernet cable to connect the computer to the **LAN2** or **LAN3/IPTV** port of the primary node.

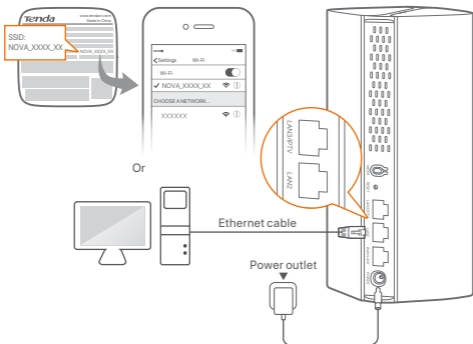

### 2. Start a browser on the client and enter **tendawifi.com** in the address bar to access the web UI, and follow the onscreen instructions to connect the device to the internet.



#### Tips

If you cannot log in to the web UI, refer to **Q3** in **FAQ**.

## Extend network

1. Place the other devices in the kit within 3 meters from the primary node to power them on. Wait for about 3 minutes. When the LED indicators of these devices light solid green, the networking is successful and these devices become secondary nodes in the network.

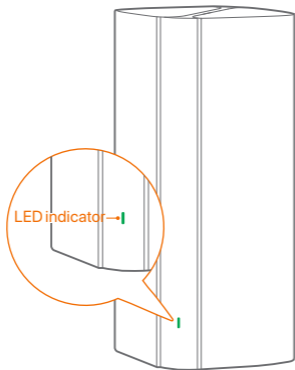

2. Please refer to the following relocation tips to locate the secondary nodes to a proper position:
  - Ensure that the distance between any two nodes is less than 10 meters.
  - Keep your nodes away from electronics with strong interference, such as microwave ovens, induction cookers, and refrigerators.
  - Place the nodes in a high position with few obstacles.



3. Power on the secondary nodes again till these LED indicators blink green slowly. The MX6 (3-pack) is taken as an example here.





**Tips**

If the LED indicator of secondary node keeps blinking green slowly for more than 3 minutes, relocate the secondary node and move it closer to the primary node.

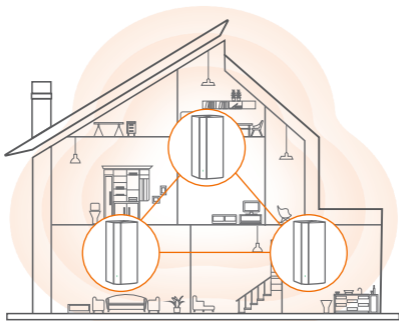
---



4. Observe the LED indicator of the secondary nodes until the LED indicator lights one of the following colors:

	Solid green	Networking succeeds. Excellent connection quality.
	Solid yellow	Networking succeeds. Fair connection quality.
	Solid red	Networking succeeds. Poor connection quality.

5. If the secondary node's LED indicator lights solid red, relocate it according to step **2** in **III Extend network** to get an optimal connection quality.

**Done.**

- To access the internet with:
  - Wired devices: Connect to the LAN ports of your nodes.
  - Wireless devices: Connect to your WiFi network using the SSID and password you set. (All nodes share the same SSID and password)
- If you configure the nodes using the Tenda WiFi App and you want to manage the network remotely, tap @ on the App home page and use your account to log in.

# FAQ

## Q1: Can I add another new set of nodes to expand my network coverage?

A1: Yes. Try the following solutions:

### Tips

Please ensure that the new node you want to add has never been used. If not, reset it first.

Method 1: Press the **MESH** button for about 1 to 3 seconds. The LED indicator blinks green fast, which indicates the device is searching for another device to form a network. Within 2 minutes, press the **MESH** button of another device for 1 to 3 seconds to negotiate with this device.

Method 2: Run the **Tenda WiFi** App and manage the network, tap ⊕ on the **My WiFi** page, and follow the on-screen instructions.

Method 3: Log in to web UI of the node, tap ⊕ on the **Network Status** page, and follow the onscreen instructions.

## Q2: How to restore my device to factory settings?

A2: When your device is working properly, hold down the **RESET** button of your device using a needle-like item (such as a pin) for about 8 seconds, and release it when the LED indicator blinks red fast. When the LED indicator lights solid green, your device is reset successfully.

## Q3: I cannot log in to the web UI by visiting [tendawifi.com](http://tendawifi.com), what should I do?

A3: Try the following solutions:

- If you are using a wireless device, such as a smart phone:
  - Ensure that it is connected to the WiFi network of the node.
  - Ensure that the cellular network (mobile data) of the client is disabled.
- If you are using a wired device, such as a computer:
  - Ensure that **tendawifi.com** is entered correctly in the address bar, rather than the search bar of the web browser.

- Ensure that the computer is connected to the LAN port of the node properly using an Ethernet cable.
- Ensure that the computer is set to **obtain an IP address automatically** and **obtain DNS server address automatically**.

If the problem persists, please reset the node and try again.

**Reset method:** When the device completes startup, hold down the **RESET** button using a needle-like item (such as a pin) for about 8 seconds, and then release it when the LED indicator blinks red fast. The device is reset successfully.

**Q4: The device failed to be detected by the Tenda WiFi app upon my first time using the device, what should I do?**

**A4:** Try the following solutions:

1. Ensure that your mobile phone is connected to the default WiFi network of the device.
2. Ensure that the network permissions of **Tenda WiFi** app is enabled. You can tap **Settings > Tenda WiFi** to enable it.

If the problem persists, please reset the node and try again.

## LED indicator status

After the device is powered on for about 40 seconds, the system completes startup. The status of the LED indicator is shown in the following table.

LED indicator status	Description
Solid green	Connected to the internet.
Solid yellow	Networking succeeds. Fair connection quality.
Solid red	Networking succeeds. Poor connection quality.
Blinking green slowly	Connecting to other nodes or waiting to connect to other nodes.
Blinking green fast	Networking by MESH button.
Blinking red slowly	Failed to connect to the internet.



## CE Mark Warning

This is a Class B product. In a domestic environment, this product may cause radio interference, in which case the user may be required to take adequate measures.

Operations in the 5.15-5.25GHz band are restricted to indoor use only.

This equipment should be installed and operated with a minimum distance 20cm between the device and your body.

The mains plug is used as disconnect device, the disconnect device shall remain readily operable.

**NOTE:** (1) The manufacturer is not responsible for any radio or TV interference caused by unauthorized modifications to this equipment. (2) To avoid unnecessary radiation interference, it is recommended to use a shielded RJ45 cable.

## Declaration of Conformity

### Declaration of Conformity

Hereby, SHENZHEN TENDA TECHNOLOGY CO., LTD. declares that the radio equipment types Mesh6X, MX6, EX6, Mesh12X, MX12 and EX12 are in compliance with Directive 2014/53/EU.

The full text of the EU declaration of conformity is available at the following internet address:  
<http://www.tendacn.com/en/service/download-cata-101.html>

Operating Frequency:

2.4 GHz: EU/2412–2472 MHz (CH1-CH13)

5 GHz: EU/5150–5350 MHz (CH36-CH64)

EIRP Power (Max.):

2.4 GHz: 19.86 dBm

5 GHz: 22.96 dBm

Software Version: V16.03.16.X (Mesh6X, MX6, EX6), V16.03.20.X (Mesh12X, MX12, EX12)



## FCC Statement

This equipment has been tested and found to comply with the limits for a Class B digital device, pursuant to Part 15 of the FCC Rules. These limits are designed to provide reasonable protection against harmful interference in a residential installation. This

equipment generates, uses and can radiate radio frequency energy and, if not installed and used in accordance with the instructions, may cause harmful interference to radio communications. However, there is no guarantee that interference will not occur in a particular installation. If this equipment does cause harmful interference to radio or television reception, which can be determined by turning the equipment off and on, the user is encouraged to try to correct the interference by one or more of the following measures:

- Reorient or relocate the receiving antenna.
- Increase the separation between the equipment and receiver.
- Connect the equipment into an outlet on a circuit different from that to which the receiver is connected.
- Consult the dealer or an experienced radio/TV technician for help.

The device is for indoor usage only.

Operation is subject to the following two conditions: (1) this device may not cause harmful interference, and (2) this device must accept any interference received, including interference that may cause undesired operation.

### **Radiation Exposure Statement**

This device complies with FCC radiation exposure limits set forth for an uncontrolled environment and it also complies with Part 15 of the FCC RF Rules.

This equipment should be installed and operated with minimum distance 20cm between the device and your body.

#### **Caution:**

Any changes or modifications not expressly approved by the party responsible for compliance could void the user's authority to operate this equipment.

This transmitter must not be co-located or operating in conjunction with any other antenna or transmitter.

Operating frequency: 2412–2462 MHz, 5150–5350 MHz, 5725–5850 MHz

**NOTE:** (1) The manufacturer is not responsible for any radio or TV interference caused by unauthorized modifications to this equipment. (2) To avoid unnecessary radiation interference, it is recommended to use a shielded RJ45 cable.



#### **Caution:**

Adapter Model: BN067-A18012E, BN074-A18012B, BN067-A18012U

Input: 100–240V AC 50/60Hz 0.6A

Output: 12V DC, 1.5A

Manufacturer: SHENZHEN HEWEISHUN NETWORK TECHNOLOGY CO., LTD.

—: DC Voltage



## RECYCLING

This product bears the selective sorting symbol for Waste electrical and electronic equipment (WEEE). This means that this product must be handled pursuant to European directive 2012/19/EU in order to be recycled or dismantled to minimize its impact on the environment.

User has the choice to give his product to a competent recycling organization or to the retailer when he buys a new electrical or electronic equipment.

Temperature: 0°C-40°C

Humidity: (10 - 90) %RH, non-condensing

For EU/EFTA, this product can be used in the following countries:

	BE	BG	CZ	DK	DE	EE	IE	EL	ES	FR	HR	IT	CY	LV
	LT	LU	HU	MT	NL	AT	PL	PT	RO	SI	SK	FI	SE	UK

UK  
CA



EAC

## **Technical Support**

Shenzhen Tenda Technology Co., Ltd.

Floor 6-8, Tower E3, No.1001, Zhongshanyuan Road, Nanshan District,  
Shenzhen, China. 518052

USA hotline: 1-800-570-5892

Toll Free: 7 x 24 hours

Canada hotline: 1-888-998-8966

Toll Free: Mon - Fri 9 am - 6 pm PST

Hong Kong hotline: 00852-81931998

Global hotline: +86 755-2765 7180 (China Time Zone)

Website: [www.tendacn.com](http://www.tendacn.com)

E-mail: [support.nova@tenda.com.cn](mailto:support.nova@tenda.com.cn)

## **Copyright**

© 2021 Shenzhen Tenda Technology Co., Ltd. All rights reserved.

Tenda is a registered trademark legally held by Shenzhen Tenda Technology Co., Ltd. Other brand and product names mentioned herein are trademarks or registered trademarks of their respective holders. Specifications are subject to change without notice.