



# Quick Installation Guide

**XPON ONT**

HG1

Please read this guide before you start with the quick setup upon the first use. This guide instructs how to install and connect the device. For more information such as the description of symbols displayed on relevant materials, please visit [www.tendacn.com](http://www.tendacn.com).

# Package contents

---

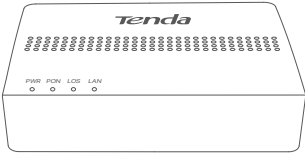

ONT x 1

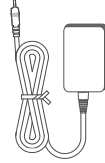

Power adapter x 1

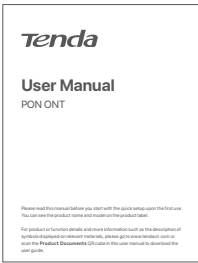

User manual x 1

# 1. Get to know your device

## LED indicator

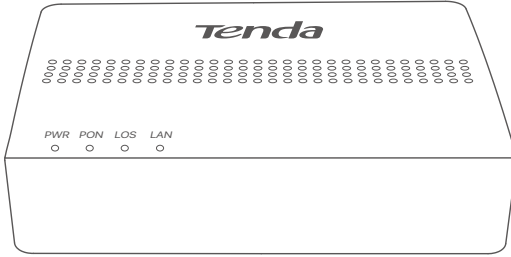

LED indicator	Color	Status	Description
PWR	Green	Solid on	Powered on
		Off	Powered off
PON	Green	Solid on	Registered successfully
		Blinking	Registering
		Off	Unregistered
LOS	Red	Blinking	Received optical power lower than optical receiver sensitivity
		Off	Received optical power at a proper value
LAN	Green	Solid on	LAN port connected properly without data transmitting
		Blinking	LAN port connected properly with data transmitting
		Off	No Ethernet device connected

## Ports, button and jack

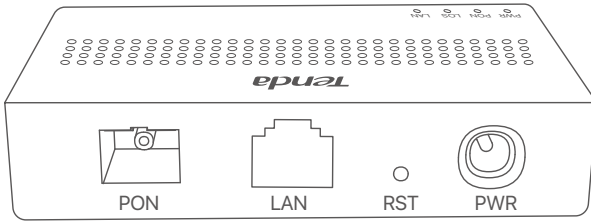

Port/Button/Jack	Description
PON	Optical fiber port Used to connect to optical network through a fiber cord.
LAN	LAN port Used to connect to a router, switch or computer.
RST	Reset button. When the <b>PWR</b> LED indicator lights solid on, use an object with a spike to hold the button down for longer than 10 seconds and release it. All LED indicators light off several seconds later. When the <b>PWR</b> LED indicator lights solid on again, the ONT is reset.
PWR	Power jack Use the included power adapter to connect the device to a power source.
Wall-mounting hole	Used to mount the device onto the wall. Wall-mounting materials are self-prepared. Recommended specifications of the expansion bolts and screws you may use are as follows: [Expansion bolt] Inner diameter: 2.4 mm; Length: 26.4 mm. [Screws] Quantity: 2; Thread diameter: 3 mm; Length: 14 mm; Head diameter: 5.2 mm.

## 2. Connect and register the ONT



### Caution, laser

DO NOT look directly at the **PON** port when the device is powered on, as well as the terminal of the indoor fiber cord, to prevent any harm to your eyes.

Connect the ONT as shown in the figure. Wait until the **PON** LED indicator lights solid on, then the ONT is registered successfully.

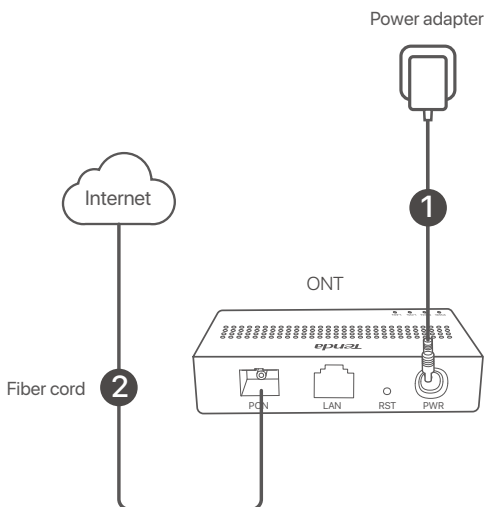

### Tips

If your ISP provides any parameters for registration, you can use them to manually register the ONT.

Method:

- 1 Use an Ethernet cable to connect a LAN port of the ONT to a wired device, such as a computer.
- 2 Enter **192.168.1.1** in a web browser and log in to the web UI of the ONT (default user name and password are both **admin**).
- 3 Navigate to **Admin > GPON Settings** (or **EPON Settings**) and enter the parameters provided by your ISP.

# 3. Configure the internet access

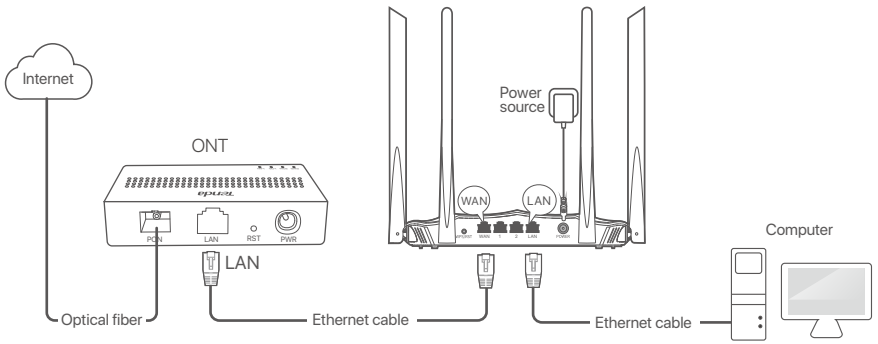

## 💡 Tips

- PPPoE is used for illustration here. Change the parameters as required by your ISP.
- Choose a desired mode to configure your internet access:  
**Router mode:** Configure the internet on the ONT.  
**Bridge mode:** Dial-up on a router or terminal.

## Router mode

### Step 1: Log in to the web UI

- 1 Use an Ethernet cable to connect a LAN port of the ONT to a wired device, such as a computer.
- 2 Start a web browser on the computer and visit **192.168.1.1**.
- 3 Enter the **User Name** and **Password** (**admin** for both by default).
- 4 Click **Login**.

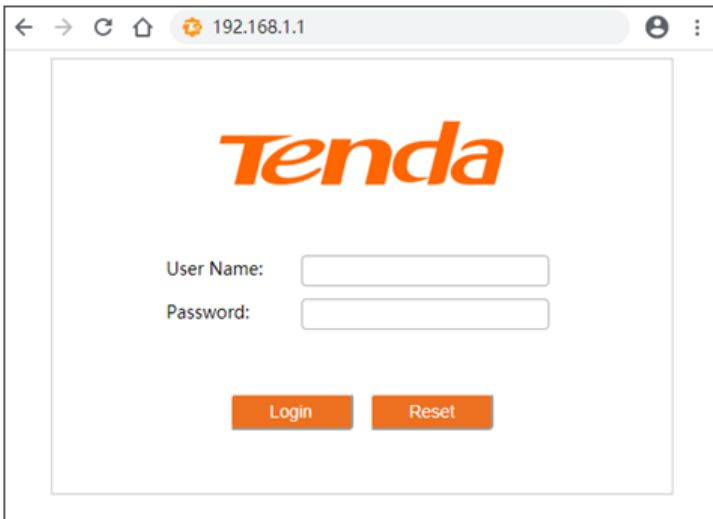

## Step 2: Set up a WAN connection

- 1 Choose **WAN > PON WAN**.
- 2 Tick **Enable VLAN**.
- 3 Enter the **VLAN ID** provided by your ISP.
- 4 Set **Channel Mode** to **PPPoE**.
- 5 Set **Connection Type** to **INTERNET**.
- 6 Enter the PPPoE **UserName** and **Password** provided by your ISP.
- 7 Set other parameters according to your ISP and your own need.
- 8 Click **Apply Changes**.
- 9 Click **OK** when **Change setting successfully** is shown on the page.

The screenshot shows the 'PON WAN' configuration page. The navigation tabs at the top are Status, LAN, WAN (selected), Services, Advance, Diagnostics, Admin, and Statistics. The left sidebar shows 'WAN' with a sub-link for 'PON WAN'. The main content area is titled 'PON WAN' and includes a sub-header: 'This page is used to configure the parameters for PONWAN'. Below this, there are several configuration fields: 'nas0\_0' (dropdown), 'Enable VLAN:' (checkbox checked), 'VLAN ID:' (input field), '802.1p\_Mark' (dropdown set to 0), 'Channel Mode:' (dropdown set to PPPoE), 'Admin Status:' (radio buttons for Enable and Disable, with Enable selected), 'Connection Type:' (dropdown set to INTERNET), 'MTU:' (input field set to 1492), and 'IP Protocol:' (dropdown set to IPv4). A section titled 'PPP Settings:' contains 'UserName:' (input field), 'Password:' (input field), 'Type:' (dropdown set to Continuous), and 'Service-Name:' (input field). At the bottom, there are 'Apply Changes' and 'Delete' buttons.

## Done.

To access the internet:

- The wired device (such as a computer) can directly access the internet.
- Connect the LAN port of the ONT to the WAN port of a Wi-Fi router (dynamic IP address) to provide wireless coverage.

# Bridge mode

## Tips

When the ONT is set to bridge mode, configure internet settings based on ISP requirements.

## Option 1: Dial-up on a router

- 1 Use an Ethernet cable to connect the LAN port of the ONT to the WAN port of a router.
- 2 Use an Ethernet cable to connect your computer to a LAN port of the router.
- 3 Set up a PPPoE connection on the router as required.

After the settings, you can access the internet through the router.

## Option 2: Dial-up on a router (Windows 10)

- 1 Use an Ethernet cable to connect the LAN port of the ONT to a computer.
- 2 Right-click  on the desktop and choose **Network Connections**.
- 3 Choose **Dial-up** and click **Set up a new connection**.

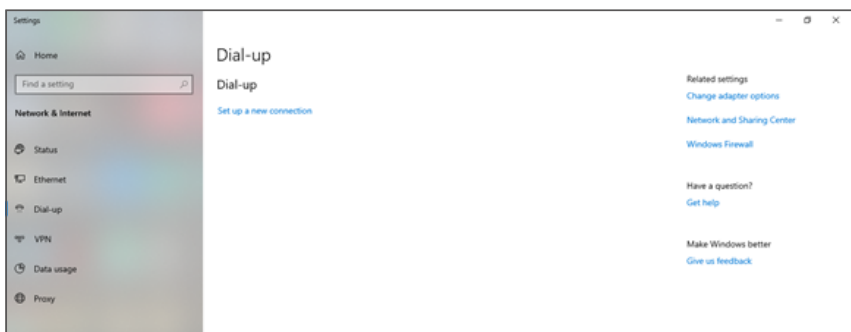



- 4 Click **Connect to the Internet** and click **Next**.

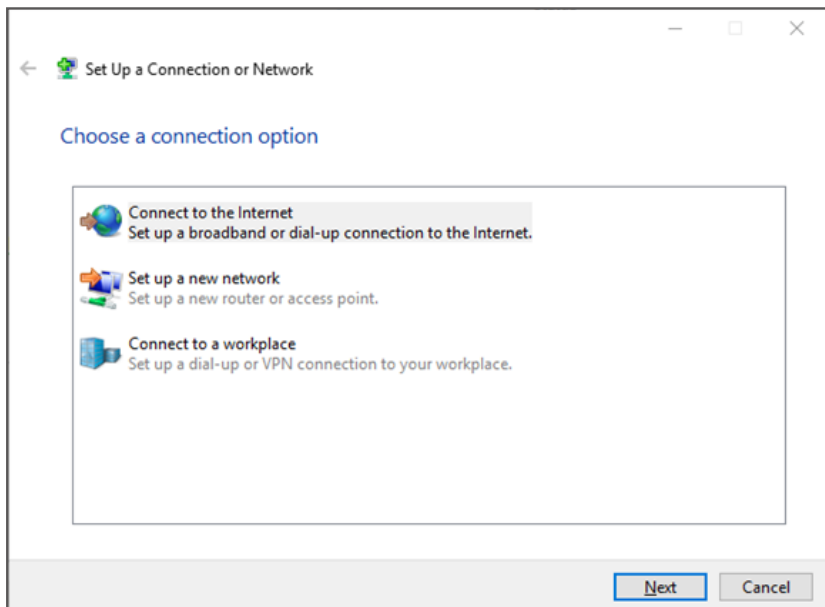

- 5 Click **Broadband (PPPoE)**.

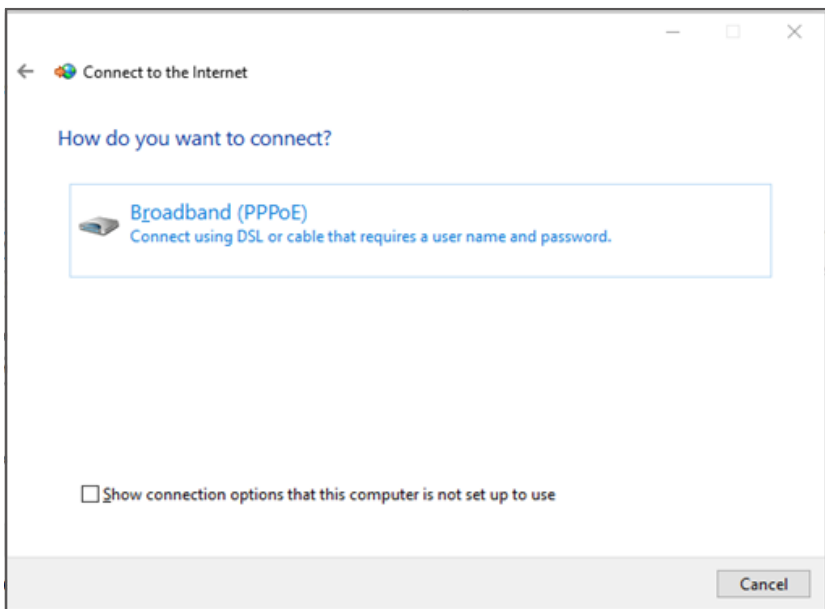

- ⑥ Enter the PPPoE **User name** and **Password** provided by your ISP and click **Connect**.

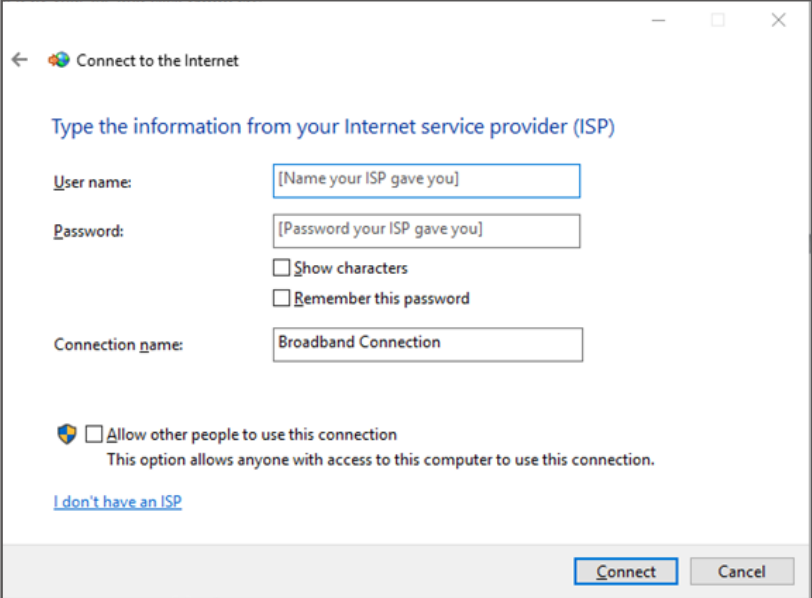

←  Connect to the Internet

Type the information from your Internet service provider (ISP)

User name:

Password:

Show characters

Remember this password

Connection name:

  Allow other people to use this connection  
This option allows anyone with access to this computer to use this connection.

[I don't have an ISP](#)

Wait a few seconds until the dial-up succeeds, and then you can access the internet on the computer.

# FAQ

---

## **Q1: I cannot log in to the web UI by visiting 192.168.1.1. What should I do?**

**A1:** Try the following solutions:

- Ensure that the ONT is powered on properly (the **PWR** LED indicator is solid green).
- When you use a wired device, such as a computer, to configure the ONT:
  - Ensure that your computer is connected to the ONT properly (the **LAN** LED indicator of the connected port lights up).
  - Ensure that your computer is set to **Obtain an IP address automatically** and **Obtain DNS server address automatically**.
  - Clear the cache of the web browser or change a web browser and try again.
  - Use another computer and try again.
- Refer to **Q4** to reset the ONT and try again.

## **Q2: I cannot access the internet after the configuration. What should I do?**

**A2:** Try the following solutions:

- Check the LED indicator status of the ONT:
  - If the **PWR** LED indicator is off, ensure that the ONT is powered on properly.
  - If the **LOS** LED indicator blinks, ensure that the **PON** port is clean and connected properly, the fiber cord is not bent excessively and the input optical power is within the normal range (Rx Power between -28 dBm to -8 dBm in GPON mode (or -27 dBm to -3 dBm in EPON mode) on the **Status > PON** page).
  - If the **PON** LED indicator blinks, the ONT is not registered. Contact your ISP or verify the parameters for registration are correct.
- Ensure that your ISP supports self-purchased PON device for internet access.
- If you set the ONT to the router mode:
  - Ensure that the ONT obtains a valid IP address and gateway on the **Status > Device > WAN Configuration** page. If not, the WAN connection is not set up successfully. Verify the parameters are correct.
  - Ensure that the wired device is connected to a LAN port of the ONT or downstream router (if any) properly and set to **Obtain an IP address automatically** and **Obtain DNS server address automatically**.
- If you set the ONT to bridge mode, ensure that the router or terminal used for dial-up is connected and configured properly.  
If the problem persists, consult your ISP.

### Q3: How to judge my PON mode?

**A3:** Navigate to the **Admin** page. If **GPON Settings** is displayed on the page, your PON mode is GPON and if **EPON Settings** is displayed on the page, your PON mode is EPON.

### Q4: How to reset the ONT?

**A4:** Method 1: When the **PWR** LED indicator lights solid on, use an object with a spike to hold the **RST** button down for longer than 10 seconds and release it. All LED indicators light off several seconds later. When the **PWR** LED indicator lights solid on again, the ONT is reset successfully.

Method 2: Log in to the web UI of the ONT, navigate to **Admin > Backup/Restore** and click **Reset** on the page.



## CE Mark Warning

This is a Class B product. In a domestic environment, this product may cause radio interference, in which case the user may be required to take adequate measures.

**NOTE:** (1) The manufacturer is not responsible for any radio or TV interference caused by unauthorized modifications to this equipment.  
(2) To avoid unnecessary radiation interference, it is recommended to use a shielded RJ45 cable.

## Declaration of Conformity

Hereby, SHENZHEN TENDA TECHNOLOGY CO., LTD. declares that the device is in compliance with Directive 2014/53/EU.

The full text of the EU declaration of conformity is available at the following internet address:

<https://www.tendacn.com/download/list-9.html>

Software Version: V1.0. X



## Caution:

Adapter Model: BN003-A05009E, BN003-A05009B

Manufacture: SHENZHEN HEWEISHUN NETWORK TECHNOLOGY CO., LTD.

Input: 100-240V AC, 50/60Hz 0.3A

Output: 9V DC, 0.6A

⎓: DC Voltage



## RECYCLING

This product bears the selective sorting symbol for Waste electrical and electronic equipment (WEEE). This means that this product must be handled pursuant to European directive 2012/19/EU in order to be recycled or dismantled to minimize its impact on the environment.

User has the choice to give his product to a competent recycling organization or to the retailer when he buys a new electrical or electronic equipment.



## FCC Statement

This equipment has been tested and found to comply with the limits for a Class B digital device, pursuant to Part 15 of the FCC Rules. These limits are designed to provide reasonable protection against harmful interference in a residential installation. This equipment generates, uses and can radiate radio frequency energy and, if not installed and used in accordance with the instructions, may cause harmful interference to radio communications. However, there is no guarantee that interference will not occur in a particular installation. If this equipment does cause harmful interference to radio or television reception, which can be determined by turning the equipment off and on, the user is encouraged to try to correct the interference by one or more of the following measures:

- Reorient or relocate the receiving antenna.
  - Increase the separation between the equipment and receiver.
  - Connect the equipment into an outlet on a circuit different from that to which the receiver is connected.
  - Consult the dealer or an experienced radio/TV technician for help.
- Operation is subject to the following two conditions: (1) this device may not cause harmful interference, and (2) this device must accept any interference received, including interference that may cause undesired operation.

### Caution!

Any changes or modifications not expressly approved by the party responsible for compliance could void the user's authority to operate the equipment.

**NOTE:** (1) The manufacturer is not responsible for any radio or TV interference caused by unauthorized modifications to this equipment.  
(2) To avoid unnecessary radiation interference, it is recommended to use a shielded RJ45 cable.

# Safety Precautions

Before performing an operation, read the operation instructions and precautions to be taken, and follow them to prevent accidents. The warning and danger items in other documents do not cover all the safety precautions that must be followed. They are only supplementary information, and the installation and maintenance personnel need to understand the basic safety precautions to be taken.

- The device is for indoor usage only.
- For wall mounting, the equipment is only suitable for mounting at heights  $\leq 2\text{m}$ .
- For desktop mounting, the device must be horizontally mounted for safe use.
- Do not use the device in a place where wireless devices are not allowed.
- Please use the included power adapter.
- Mains plug is used as the disconnect device, and shall remain readily operable.
- The power socket shall be installed near the device and easily accessible.
- Operating environment: Temperature:  $0^{\circ}\text{C}$  to  $40^{\circ}\text{C}$  ;  
Humidity: (10% - 90%) RH, non-condensing;
- Storage environment: Temperature:  $-40^{\circ}\text{C}$  to  $+70^{\circ}\text{C}$  ;  
Humidity: (5% - 90%) RH, non-condensing.
- Keep the device away from water, fire, high electric field, high magnetic field, and inflammable and explosive items.
- Unplug this device and disconnect all cables during lightning storms or when the device is unused for long periods.
- Do not use the power adapter if its plug or cord is damaged.
- If such phenomena as smoke, abnormal sound or smell appear when you use the device, immediately stop using it and disconnect its power supply, unplug all connected cables, and contact the after-sales service personnel.
- Disassembling or modifying the device or its accessories without authorization voids the warranty, and might cause safety hazards.

## **Technical Support**

Shenzhen Tenda Technology Co., Ltd.

Floor 6-8, Tower E3, No.1001, Zhongshanyuan Road, Nanshan District, Shenzhen, China. 518052

Website: [www.tendacn.com](http://www.tendacn.com)

E-mail: [support@tenda.com.cn](mailto:support@tenda.com.cn)

## **Copyright**

© 2023 Shenzhen Tenda Technology Co., Ltd. All rights reserved. Tenda is a registered trademark legally held by Shenzhen Tenda Technology Co., Ltd. Other brand and product names mentioned herein are trademarks or registered trademarks of their respective holders. Specifications are subject to change without notice.

V1.1 Keep for future reference