

Web User Guide

Security Camera



Copyright Statement

© 2021-2022 Shenzhen Tenda Technology Co., Ltd. All rights reserved.

Tenda is a registered trademark legally held by Shenzhen Tenda Technology Co., Ltd. Other brand and product names mentioned herein are trademarks or registered trademarks of their respective holders. Copyright of the whole product as integration, including its accessories and software, belongs to Shenzhen Tenda Technology Co., Ltd. No part of this publication can be reproduced, transmitted, transcribed, stored in a retrieval system, or translated into any language in any form or by any means without the prior written permission of Shenzhen Tenda Technology Co., Ltd.

Disclaimer

Pictures, images and product specifications herein are for references only. To improve internal design, operational function, and/or reliability, Tenda reserves the right to make changes to the products without obligation to notify any person or organization of such revisions or changes. Tenda does not assume any liability that may occur due to the use or application of the product described herein. Every effort has been made in the preparation of this document to ensure accuracy of the contents, but all statements, information and recommendations in this document do not constitute a warranty of any kind, express or implied.

Preface

Thank you for choosing Tenda! Please read this guide before you use this product.

Applicable models



This user guide applies to the Tenda camera that supports web management. The actual product image and firmware function prevail. Unless otherwise specified, IT7-LCS is used for illustration here.

Conventions

The typographical elements that may be found in this document are defined as follows.

Item	Presentation	Example
Cascading menus	>	System > Live Users
Parameter and value	Bold	Set User Name to Tom .
Variable	Italic	Format: <i>XX:XX:XX:XX:XX:XX</i>
UI control	Bold	On the Policy page, click the OK button.
Message	“ ”	The “Success” message appears.

The symbols that may be found in this document are defined as follows.

Symbol	Meaning
 NOTE	This format is used to highlight information of importance or special interest. Ignoring this type of note may result in ineffective configurations, loss of data or damage to the device.
 TIP	This format is used to highlight a procedure that will save time or resources.

For more documents

If you want to get more documents about the device, visit www.tendacn.com and search for the corresponding product model.

The related documents are listed as below.

Document	Description
Datasheet	It introduces the basic information of the device, including product overview, selling points, and specifications.
Quick Installation Guide	It introduces how to set up the camera quickly for internet access, the descriptions of LED indicators, ports, and buttons, FAQ, statement information, and so on.
Web User Guide	It introduces how to set up more functions of the camera for more requirements, including all functions on the web UI of the device.
App User Guide	It introduces how to use the TDSEE app to manage the camera.

Technical Support

Contact us if you need more help. We will be glad to assist you as soon as possible.

Email address: tendasecurity@tenda.cn

Website: www.tendacn.com

Revision History

Tenda is constantly searching for ways to improve its products and documentation. The following table indicates any changes that might have been made since the camera was released.

Version	Description	Date
V1.1	1. Added such functions as Auto IP Address and Fixed IP 2. Optimized such functions as Time Settings , Image and Basic Event 3. Optimized sentence expression	2022-09-20
V1.0	Original publication	2021-11-15

Contents

1	Camera Management Method.....	1
1.1	Manage the Camera through NVR	1
1.1.1	Ordinary Camera	1
1.1.2	PoE Camera	2
1.2	Manage the Camera through Web UI	5
1.3	Manage the Camera through TDSEE App	7
2	Log in to Web UI.....	8
2.1	Login	8
2.1.1	With NVR in the Network.....	8
2.1.2	Without NVR in the Network	10
2.2	Logout	11
2.3	Web UI.....	12
2.3.1	Layout.....	12
2.3.2	Frequently-used Elements	13
3	Log.....	14
4	Configuration.....	16
4.1	System	16
4.1.1	Device Info.....	16
4.1.2	Time Settings.....	17
4.1.3	System Maintenance	20
4.2	Network.....	22
4.2.1	TCP/IP	22
4.2.2	Port.....	24
4.2.3	Email.....	25

4.3 Video/Audio	30
4.4 Image.....	32
4.4.1 Display Settings	32
4.4.2 OSD Settings.....	36
4.4.3 Privacy Mask	39
4.5 Security.....	41
4.5.1 User	41
4.5.2 Security Service	44
4.6 Basic Event	46
4.6.1 Overview	46
4.6.2 Configure Area Intrusion Alarm	48
4.6.3 Configure Human Detection Alarm.....	50
Appendixes.....	52
A.1 Configure your computer to obtain an IPv4 address automatically.....	52
A.2 Default parameter values	57
A.3 Acronyms and Abbreviations.....	58

1 Camera Management Method

Tenda security cameras include ordinary cameras and PoE cameras. You can manage the camera through Network Video Recorder (NVR), web UI and the TDSEE app. Select the proper management method according to the actual situation.

1.1 Manage the Camera through NVR

1.1.1 Ordinary Camera

Step 1 Connect devices.

You can refer to the following figure to connect devices.

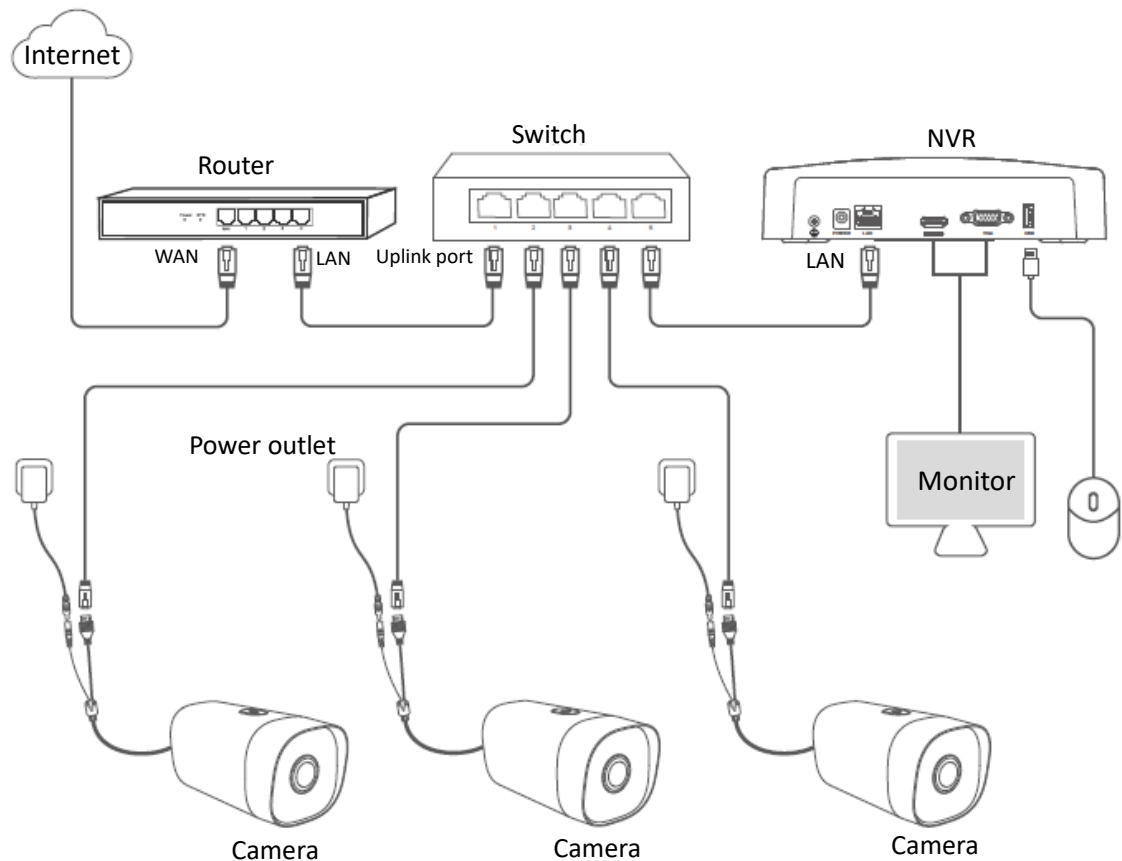

Step 2 Manage the camera.

Enter the web UI of the NVR to manage the camera, and perform the related configurations according to the actual situation.

Refer to the user guide of the corresponding NVR model for details.

---End



For network security, [modify your username and password](#) in time. If the camera has been successfully managed by the NVR, modifying the login username or password may cause the camera to go offline. Please operate with caution.

1.1.2 PoE Camera

The IT7-PRS is taken as an example here.



If the PoE camera supports DC power supply, you need to self-prepare a power adapter (port specification: 5.5*2.1 mm, power-related parameters can be found on the label attached to the device) that meets the requirements to power the camera.

Used with Ordinary NVR

Step 1 Connect devices.

You can refer to the following figure to connect devices.

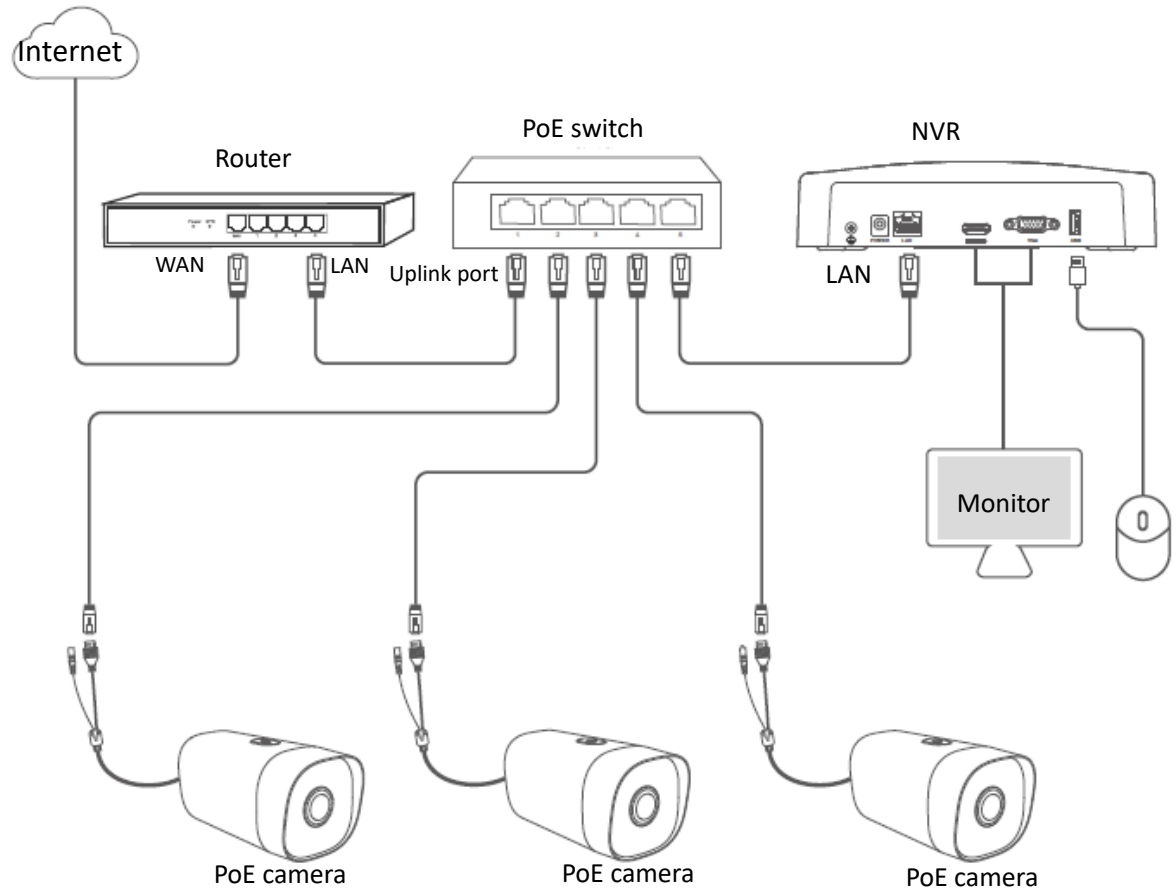

Step 2 Manage the camera.

Enter the web UI of the NVR to manage the camera, and perform the related configurations according to the actual situation.

Refer to the user guide of the corresponding NVR model for details.

---End

NOTE

For network security, [modify your username and password in time](#). If the camera has been successfully managed by the NVR, modifying the login username or password may cause the camera to go offline. Please operate with caution.

Used with PoE NVR

Step 1 Connect devices.

You can refer to the following figure to connect devices.

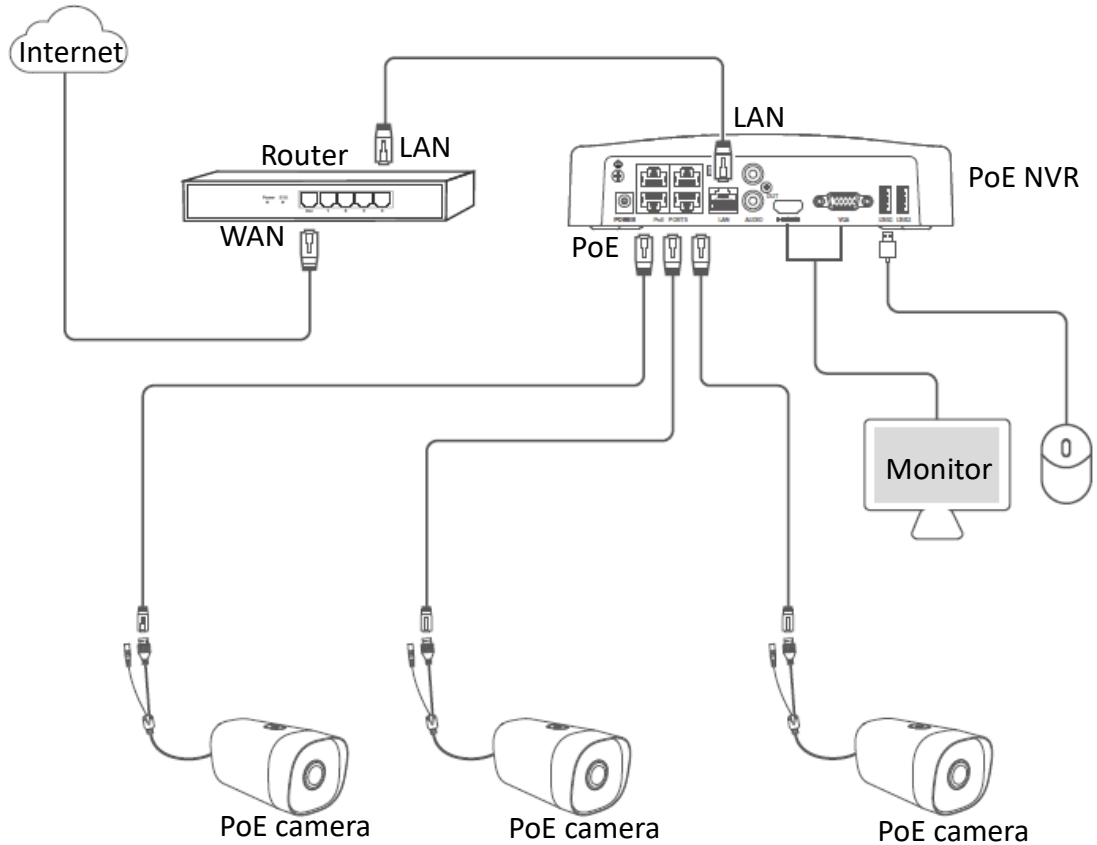

Step 2 Manage the camera.

Enter the web UI of the NVR to manage the camera, and perform the related configuration according to the actual situation.

Refer to the user guide of the corresponding NVR model for details.

---End

1.2 Manage the Camera through Web UI

- Step 1** Connect the computer to the Ethernet port of the camera, or to a switch or router that is connected to the camera.
- Step 2** Set the IP address of the computer to an unused one belonging to the same network segment as the IP address of the camera but different from the IP address of the camera. The following figure is for reference only.

The camera supports three IP address acquisition methods: **DHCP**, **Auto IP address** and **Fixed IP**. By default, the camera works in the **Auto IP address**.

If you search for a camera on the web UI or GUI of the NVR in the network, the IP address of the camera will be automatically synchronized to the same network segment as the IP address of the NVR, you can view the current IP address of the camera on the web UI or GUI of the NVR. If not, the camera keeps the default IP address (192.168.1.203).



TIP

After a camera is stably added to an NVR for 24 hours, the IP address acquisition method of the camera will be automatically changed to **Fixed IP**.

Internet Protocol Version 4 (TCP/IPv4) Properties

General

You can get IP settings assigned automatically if your network supports this capability. Otherwise, you need to ask your network administrator for the appropriate IP settings.

Obtain an IP address automatically

Use the following IP address:

IP address: 192 . 168 . 1 . 10

Subnet mask: 255 . 255 . 255 . 0

Default gateway: . . .

Obtain DNS server address automatically

Use the following DNS server address:

Preferred DNS server: . . .

Alternate DNS server: . . .

Validate settings upon exit

Advanced...

OK Cancel

- Step 3** Start a browser and enter the IP address of the camera in the address bar to access the login page. Enter the **User Name** (default: admin) and **Password** (default: admin123456), and then click **Login**.

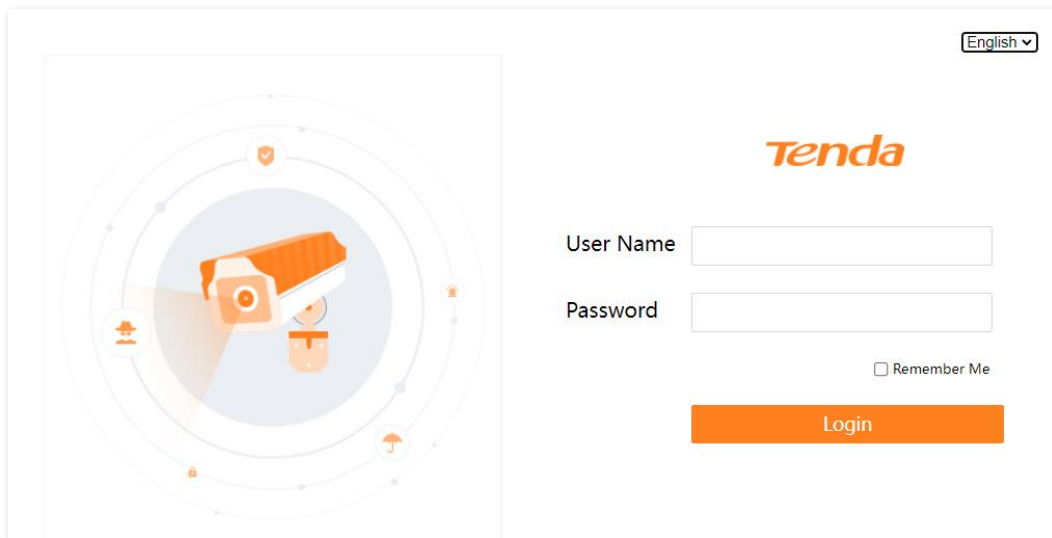

---End

After you successfully log in to the web UI of the camera, you can start to configure the camera as required.

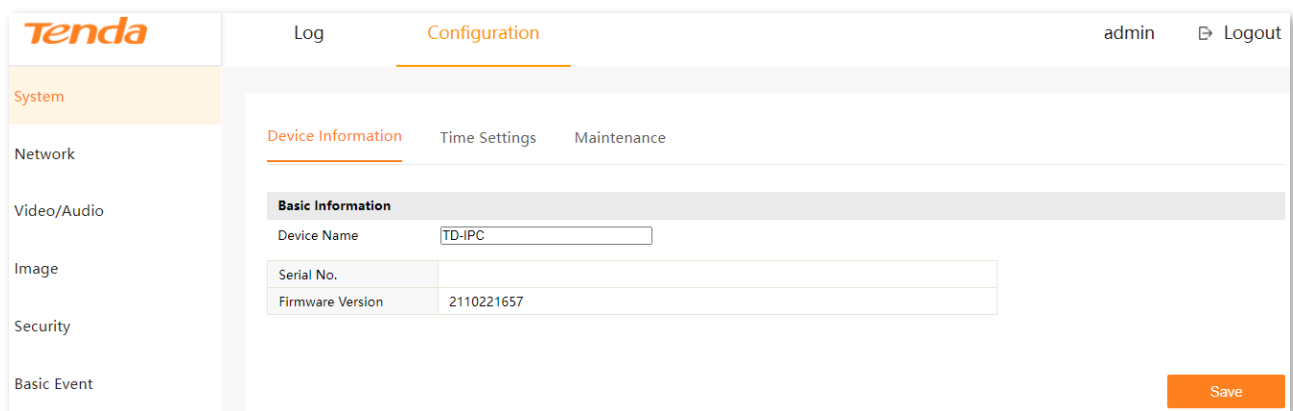

For network security, [modify your username and password](#) in time. If the camera has been successfully managed by the NVR, modifying the login username or password may cause the camera to go offline. Please operate with caution.

1.3 Manage the Camera through TDSEE App

Step 1 Connect devices.

You can refer to the following figure to connect devices.



The smartphone has connected to the Wi-Fi of the router, and can access the internet.

TDSEE app has been installed on your smartphone.

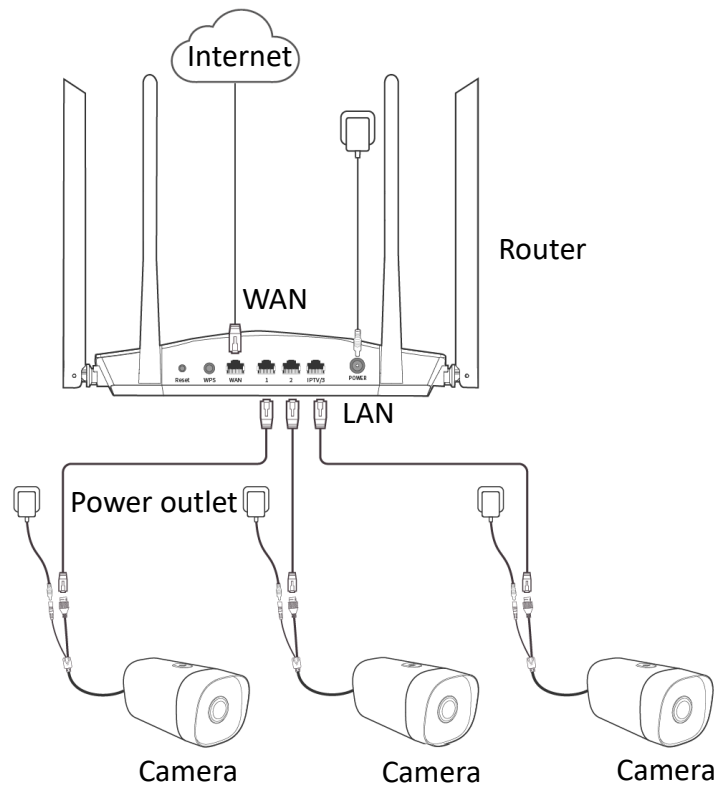

Step 2 Manage the camera.

Run the TDSEE app. Enter the **Home** page, tap **Add a device** or  in the upper right corner of the home page, then follow the instructions to operate.

Refer to the user guide of the TDSEE app for details.

---End

2 Log in to Web UI

2.1 Login

The camera supports three IP address acquisition methods: **DHCP**, **Auto IP address** and **Fixed IP**. By default, the camera works in the **Auto IP address**.

This chapter mainly describes how to log in to the web UI of the camera when the IP address of the camera acquisition method is **Auto IP Address**. If not, refer to [TCP/IP](#).

**TIP**

- After a camera is stably added to an NVR for 24 hours, the IP address acquisition method of the camera will be automatically changed to **Fixed IP**.
- If the PoE camera has been connected to the PoE port of the PoE NVR, the computer connected to the LAN side of the NVR cannot log in to the web UI of the camera. Because the PoE camera and the computer are not on the same LAN at this time.

2.1.1 With NVR in the Network

If the NVR is in the network, the IP address of the camera will be automatically synchronized to the same network segment as the IP address of the NVR.

Step 1 Connect the computer to the switch or router that is connected to the NVR.

Step 2 Log in to the web UI or GUI of the NVR to view the IP address of the camera. Assume that the IP address obtained by the camera is 192.168.0.243.

**TIP**

If you cannot find the camera on the web UI or GUI of the NVR, try to search again.

Step 3 Set the IP address of the computer to an unused one belonging to the same network segment as the IP address of the camera but different from the IP address of the camera. The following figure is for reference only.

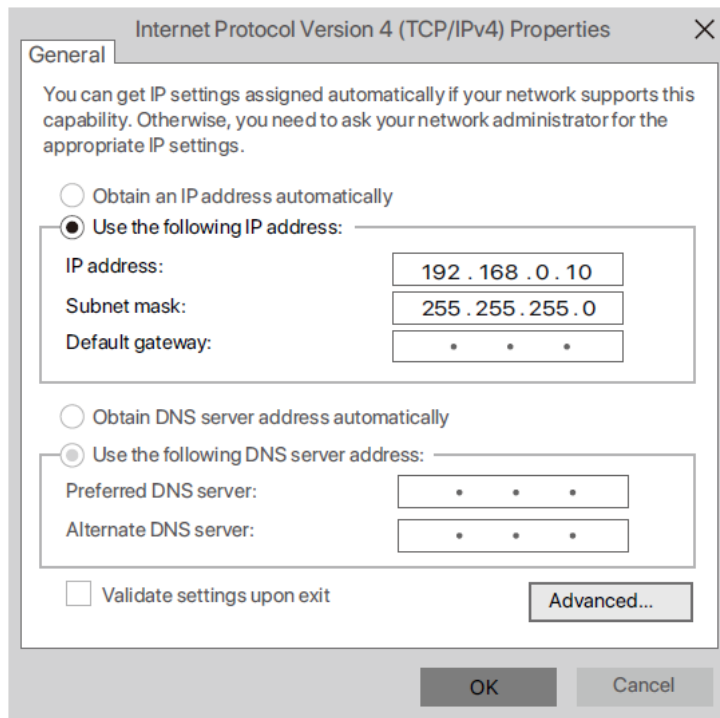

- Step 4** Start a browser and enter the IP address of the camera in the address bar to access the IP address of the camera. Enter the **User Name** (default: admin) and **Password** (default: admin123456), and click **Login**.

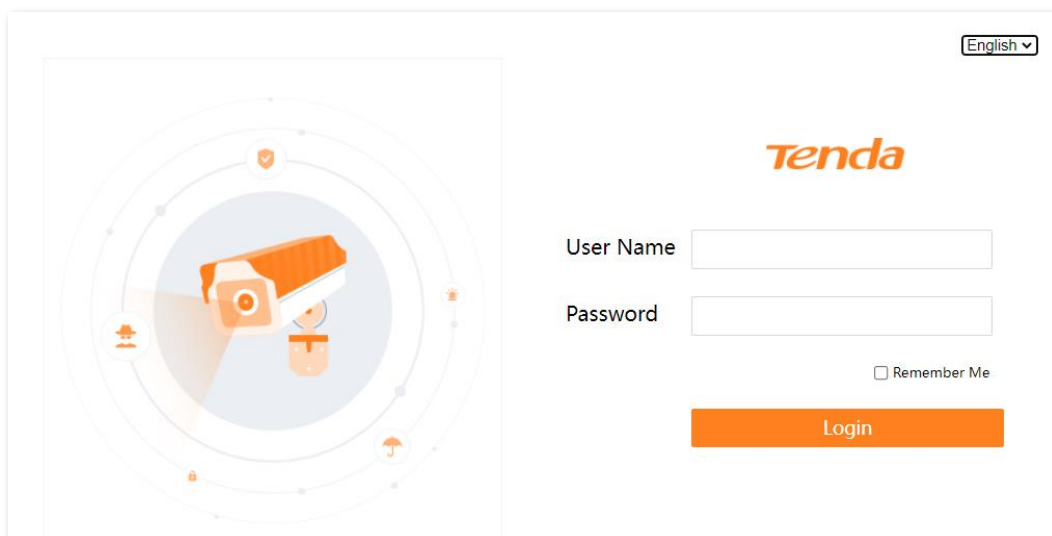

---End

After you successfully log in to the web UI of the camera, you can start to configure the camera as required.

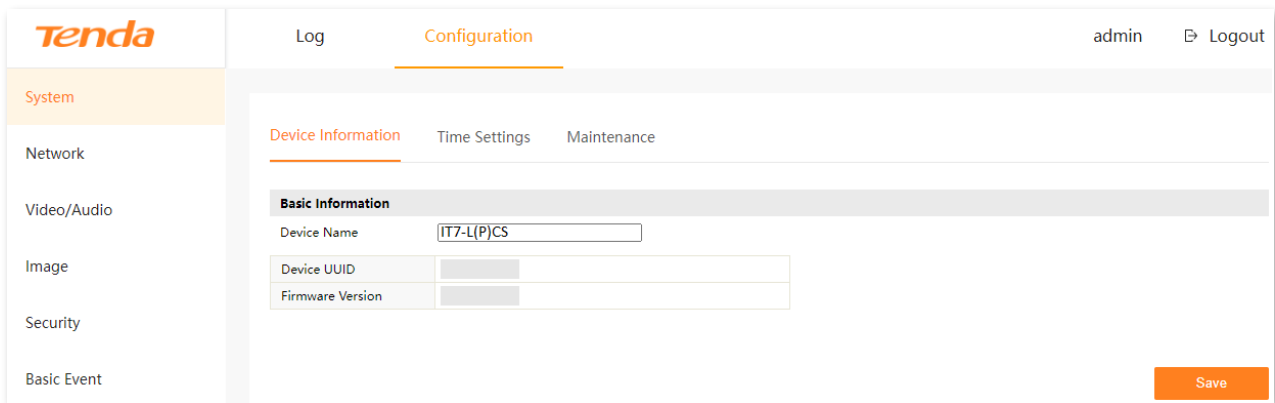

2.1.2 Without NVR in the Network

If the NVR is not in the network, the camera keeps the default IP address (192.168.1.203).

- Step 1** Connect the computer to the Ethernet port of the camera, or to the switch or router that is connected to the camera.
- Step 2** Set the IP address of the computer to an unused one belonging to the same network segment as the IP address of the camera but different from the IP address of the camera. The following figure is for reference only.

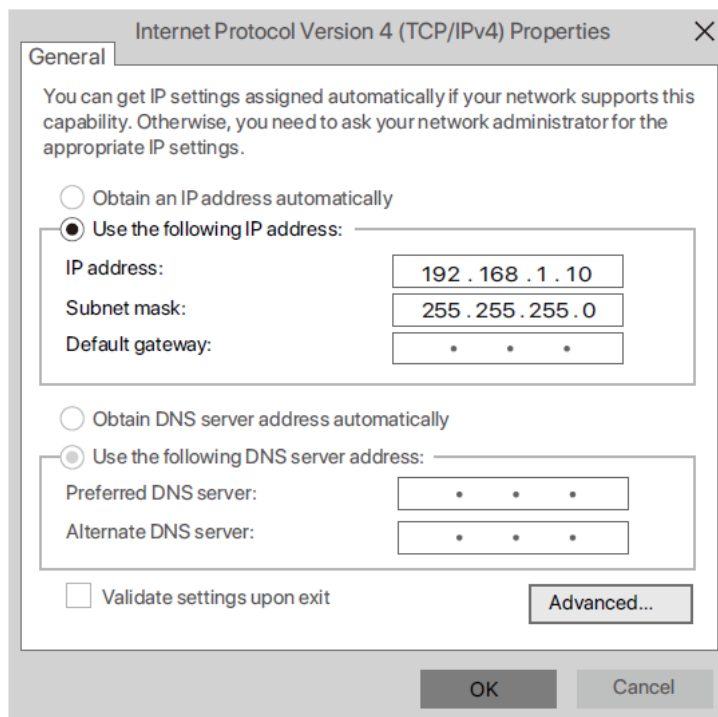

- Step 3** Start a browser and enter the default IP address 192.168.1.203 of the camera in the address bar. Enter the **User Name** (default: admin) and **Password** (default: admin123456), then click **Login**.

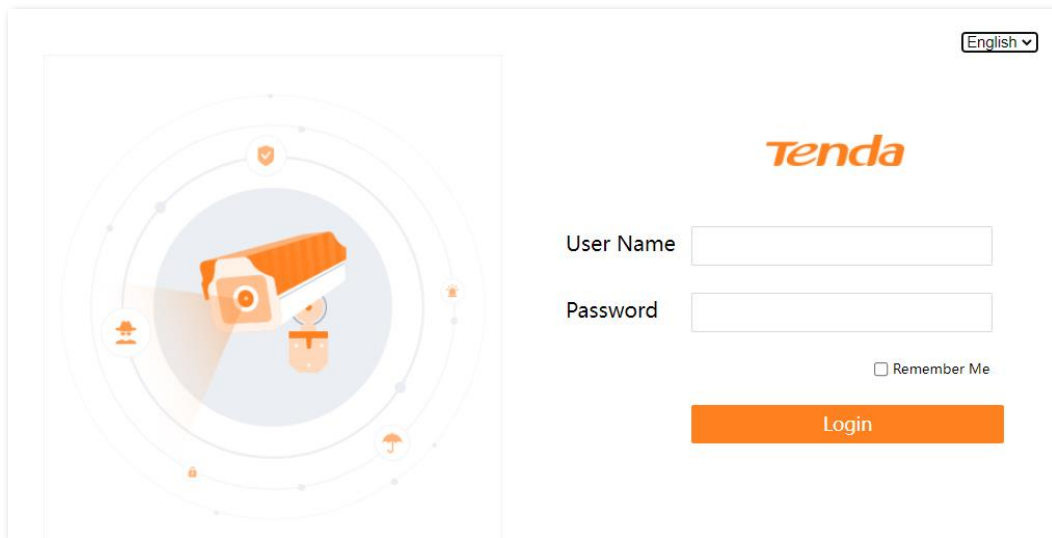

---End

After you successfully log in to the web UI of the camera, you can start to configure the camera as required.

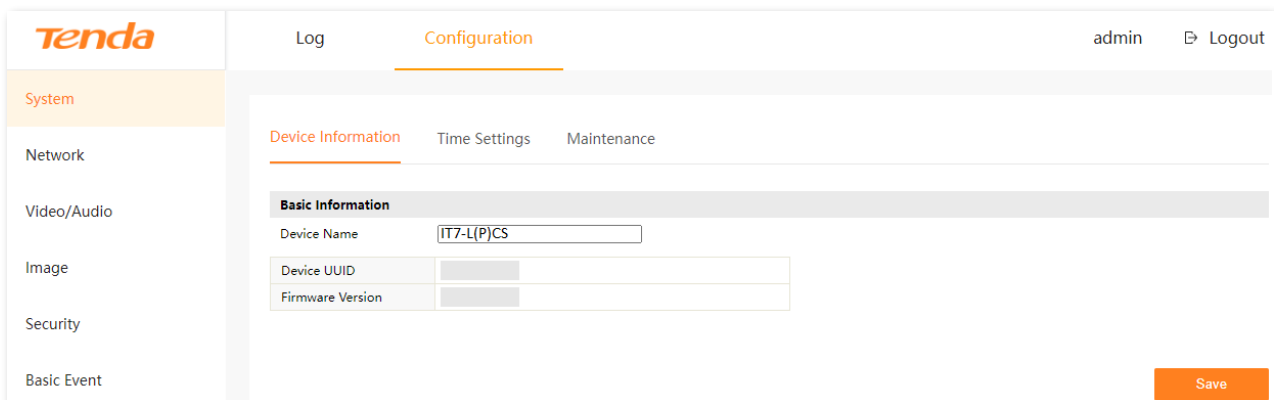

2.2 Logout

You can log out by clicking **Logout** at the upper-right corner of the web UI.

2.3 Web UI

2.3.1 Layout

The web UI of the camera consists of two sections, including the navigation bar and the configuration area. See the following figure.

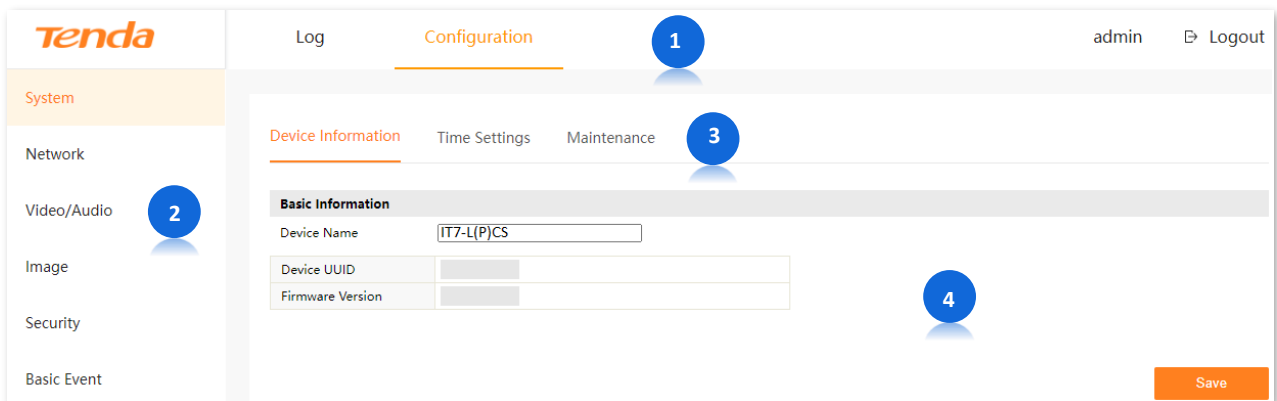

Features and parameters in gray indicate that they are not available or cannot be changed under the current configuration.

No.	Name	Description
1	Navigation bar	Used to display the function menu of the camera. You can select functions in the navigation bar and then the configuration appears in the configuration area.
2		
3	Tab	
4	Configuration area	Used to view or modify your configuration.

2.3.2 Frequently-used Elements

The following table describes the frequently-used buttons available on the web UI of the NVR.

Button	Description
Save	Used to save the configuration on the current page and enable the configuration to take effect.
Cancel	Used to cancel the changes you did before.

3 Log

Click **Log** to enter the page.

You can view the related information of the log according to the log type here.

Search Log

Major Type: All Types Start Time: 2022-08-31 00:00:00 End Time: 2022-08-31 23:59:59 Search

Assume that you want to view the operation information for the whole day on August 31, 2022.

Procedure:

- Step 1** [Log in to the web UI](#), and click **Log**.
- Step 2** Set **Major Type**, which is **Operation** in this example.
- Step 3** Select the **Start Time** and **End Time**, which are **00:00:00** to **23:59:59** on **August 31, 2022**, in this example.
- Step 4** Click **Search**.

Search Log

Major Type: Operation Start Time: 2022-08-31 00:00:00 End Time: 2022-08-31 23:59:59 Search

Time	Major Type	Log Content	Host IP
------	------------	-------------	---------

Step 5 Click **OK** on the pop-up window.

---End

Completed. You can view the related information as required.

Search Log

Major Type Start Time End Time

	Time	Major Type	Log Content	Host IP
1	2022-08-31 09:06:40	Operation	WEB:ImageModify	192.168.10.95
2	2022-08-31 09:06:37	Operation	WEB:ISPMoDeModify	192.168.10.95
3	2022-08-31 09:06:31	Operation	WEB:MotionDetectionModify	192.168.10.95
4	2022-08-31 09:05:15	Access	WEB:RemoteLogin	192.168.10.95
5	2022-08-31 08:51:44	Access	WEB:RemoteLogin	192.168.10.95

4 Configuration

On the **Configuration** page, you can:

- [View device information, set system time, maintain the system](#)
- [Set image parameters, OSD display, privacy area](#)
- [Set internet parameters, modify each services port, configure email alarm](#)
- [Manage login account, set ONVIF authentication](#)
- [Modify video parameters](#)
- [Set motion detection alarm](#)

4.1 System

4.1.1 Device Info

Navigate to **Configuration > System > Device Information**.

You can view the basic information of the camera here, including device name, device UUID and firmware version.

The screenshot displays the 'Configuration' page of a camera's web interface. At the top, there are tabs for 'Log' and 'Configuration', with 'Configuration' being the active tab. The user is logged in as 'admin' and can click 'Logout'. Below the navigation, there are three sub-sections: 'Device Information' (selected), 'Time Settings', and 'Maintenance'. The 'Device Information' section is titled 'Basic Information' and contains three input fields: 'Device Name' with the value 'IT7-L(P)CS', 'Device UUID', and 'Firmware Version'. A 'Save' button is located at the bottom right of the form.

Basic Information	
Device Name	<input type="text" value="IT7-L(P)CS"/>
Device UUID	<input type="text"/>
Firmware Version	<input type="text"/>

Save

Parameter description

Parameter	Description
Device Name	Specifies the name of the camera.
Device UUID	Specifies the UUID of the camera, which can be found on the bottom of the device.
Firmware Version	Specifies the version of the current system firmware.

4.1.2 Time Settings

Overview

Navigate to **Configuration > System > Time Settings**.

You can set the system time of the camera here. To ensure that the time-based functions of the camera take effect normally, the system time of the camera must be accurate. The camera supports two time-setting methods: [NTP](#) and [Manual Time Sync](#). The default is **NTP**. After the camera is added successfully to the NVR, the time-setting method is automatically changed to **Manual Time Sync** and the system time of the NVR is synchronized.

- **NTP:** Sync the time of the NTP server according to the synchronization interval.
- **Manual Time Sync.:** Set the system time manually.

Device Information **Time Settings** Maintenance

Time Zone (GMT+08:00) Beijing, Urumqi, Singapore ▼

Time Sync.

NTP

Server Address time.windows.com

Interval 60 min.

Manual Time Sync.

Device Time 2022-08-24T10:26:58

Set Time 2022-08-24T10:26:18 Sync. with computer time

Save

Parameter description

Parameter	Description	
Time Zone	Specifies the standard time area in which the camera locates.	
NTP	Specifies the address of the time server. Network Time Protocol (NTP) is used to synchronize the time between the client and the network time server. After the NTP is enabled, the camera will synchronize the system time through this NTP server according to the Interval .	
	Interval	Specifies the time interval at which the camera synchronizes the system time to the NTP server.
	Device Time	Specifies the current system time of the camera.
Manual Time Sync.	Specifies you can set up the system time manually. You can set up the system time manually, and can also tick Sync. with computer time to sync the system time with the time of the terminal device currently logging in to the web UI of the camera.	

Synchronize the System Time Through the Internet

After the camera is successfully connected to the internet, the system time will automatically synchronize with the NTP server according to the **Interval**. You can modify the NTP server and time synchronization according to the actual situation.

Refer to [TCP/IP](#) for the internet access methods of the camera.

Procedure:

- Step 1** [Log in to the web UI](#), and navigate to **Configuration > System > Time Settings**.
- Step 2** Select the time area in which the camera locates.
- Step 3** Set **Time Sync.**, which is **NTP** in this example.
- Step 4** Click **Save**.

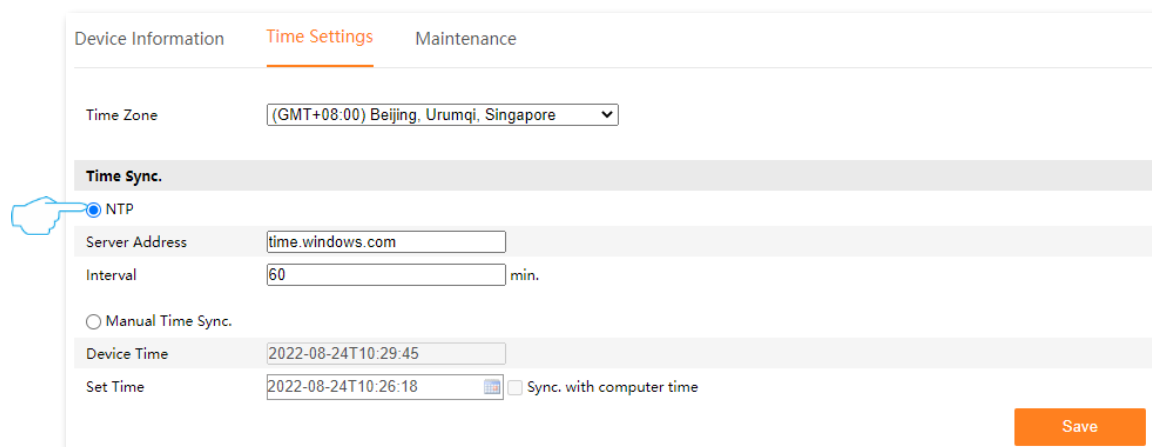

Device Information **Time Settings** Maintenance

Time Zone: (GMT+08:00) Beijing, Urumqi, Singapore

Time Sync.

NTP

Server Address: time.windows.com

Interval: 60 min.

Manual Time Sync.

Device Time: 2022-08-24T10:29:45

Set Time: 2022-08-24T10:26:18 Sync. with computer time

Save

---End

After the setting completes, refresh the page, and you can view whether the **Device Time** on the page is accurate.

Manually Synchronize the System Time

Manually setting the system time of the camera is used when the camera is disconnected from the internet.

- Step 1** [Log in to the web UI](#), and navigate to **Configuration > System > Time Settings**.
- Step 2** Set **Time Sync.**, which is **Manual Time Sync.** in this example.
- Step 3** Set date and time. The following figure is for reference only.
- Step 4** Click **Save**.

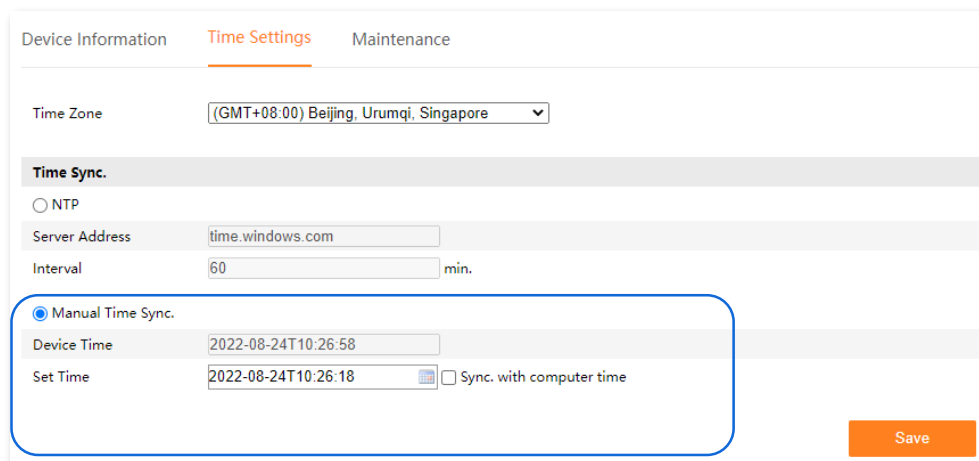

Device Information **Time Settings** Maintenance

Time Zone: (GMT+08:00) Beijing, Urumqi, Singapore

Time Sync.

NTP

Server Address: time.windows.com

Interval: 60 min.

Manual Time Sync.

Device Time: 2022-08-24T10:26:58

Set Time: 2022-08-24T10:26:18 Sync. with computer time

Save

---End

After the setting completes, you can view whether the **Device Time** on the current page is accurate.

4.1.3 System Maintenance

Reboot

If the camera occurs such phenomena as performance degradation, instability, and some abnormal parameters, you can reboot the camera.

Step 1 [Log in to the web UI](#) and navigate to **Configuration > System > Maintenance**.

Step 2 Click **Reboot**.

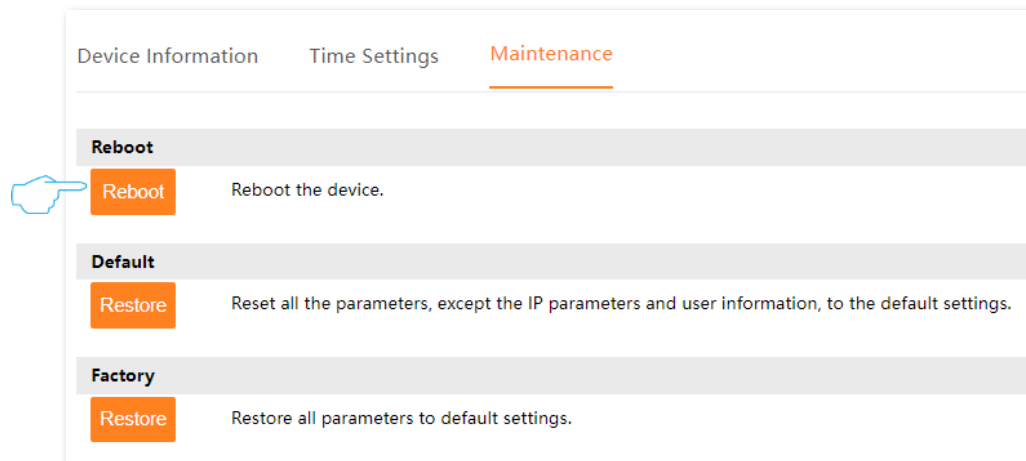

Step 3 Read the prompt message, and click **OK**.

---End

A prompt message will appear on the page. Please wait with patience.

Restore Settings

If the camera is running slowly or a configuration error occurs, you can try to restore the NVR.

- Restore the default settings: Except for the [TCP/IP](#) configuration, all other settings are restored to the factory settings.
- Restore factory settings: Restore all settings of the camera to the factory settings.



- When the camera is restored to the settings, it will disconnect all current connections.
- To avoid damaging the camera, ensure that the camera is powered on properly during the process of restoring the factory settings.

Procedure:

Step 1 [Log in to the web UI](#), and navigate to **Maintenance > System > System Maintenance**.

Step 2 Select **Default** or **Factory** according to the actual situation, then click **Restore**.

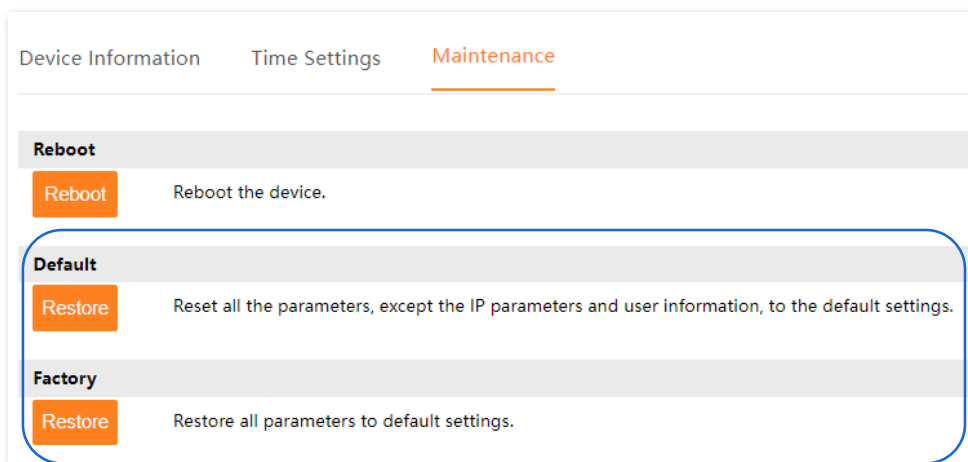

Step 3 Read the prompt message, and click **OK**.

---End

A prompt message will appear on the page. Please wait with patience.

4.2 Network

4.2.1 TCP/IP

Navigate to **Configuration > Network > TCP/IP**.

You can view the LAN port parameters of the camera, and can also modify the LAN port parameter to connect the camera to the internet here.

NIC Settings		
<input type="checkbox"/> DHCP	<input checked="" type="checkbox"/> Auto IP Address	<input type="checkbox"/> Fixed IP
IPv4 Address	<input type="text" value="192.168.10.79"/>	
IPv4 Subnet Mask	<input type="text" value="255.255.255.0"/>	
IPv4 Default Gateway	<input type="text" value="192.168.10.1"/>	
Mac Address	<input type="text" value="50:2b:73:f9:ce:b6"/>	
DNS Server		
Preferred DNS Server	<input type="text" value="114.114.114.114"/>	
Alternate DNS Server	<input type="text" value="223.5.5.5"/>	
<input type="button" value="Save"/>		

Parameter description

Parameter	Description
DHCP	<p>Specifies whether to enable the function of the camera automatically obtain an IP address from an upstream device.</p> <p>After the DHCP is enabled, the camera can automatically obtain its IP address, subnet mask, default gateway and DNS server from the DHCP server in the network.</p>
Auto IP Address	<p>Specifies whether to enable the function of the camera's IP address synchronization with the NVR.</p> <p>After it is enabled, if you search the camera on the web UI or GUI of the NVR in the network, the IP address of the camera will be automatically synchronized to the same network segment as the IP address of the NVR.</p> <p> NOTE</p> <ul style="list-style-type: none"> – If the IP address of the camera has never been synchronized and there is no NVR in the network, the camera keeps the default IP address (192.168.1.203). – If the IP address of the camera has been synchronized, and there is no NVR in the network, the IP address of the camera keeps the IP address when the last synchronization was successful. – After the camera is stably added to the NVR for 24 hours, the IP address acquisition method of the camera will be automatically changed to Fixed IP.

Parameter	Description
Fixed IP	<p>Specifies such information as the IP address of the camera can be set manually.</p> <p>After it is enabled, you can manually specify the IP address, subnet mask, default gateway, and DNS server of the camera.</p>
IPv4 Address	<p>Specifies the IP address (also called the management IP address) of the camera. The user who is on the same LAN as the camera can log in to the web UI using this IP address.</p> <p>To connect the camera to the internet, the IP address of the camera must be set in the same network segment of the LAN IP address of the router with internet connectivity.</p>
IPv4 Subnet Mask	Specifies the subnet mask of the camera.
IPv4 Default Gateway	<p>Specifies the default gateway of the camera.</p> <p>You can configure the default gateway of the camera to the LAN IP address of the router with internet connectivity.</p>
Mac Address	Specifies the LAN MAC address of the camera.
Preferred DNS Server	<p>Specify the primary or secondary DNS server address of the camera.</p> <p>If the router with internet connectivity has a DNS proxy function, the Preferred DNS Server can be set to the IP address of the LAN port of the router with internet connectivity. Otherwise, enter the correct IP address of the DNS server.</p>
Alternate DNS Server	If there is only one DNS server IP address, please file in Preferred DNS Server .

4.2.2 Port

Navigate to **Configuration > Network > Port**.

Ports number indicate different network services. For example, port 80 indicates web service. You can view or modify each service port number here.

TCP/IP	Port	Email
HTTP Port	<input type="text" value="80"/>	
RTSP Port	<input type="text" value="8554"/>	
Server Port	<input type="text" value="6688"/>	

[Save](#)

Parameter description

Parameter	Description
HTTP Port	<p>Specifies the port number for the HTTP. The default settings are recommended.</p> <p>Once the HTTP port is modified, when you log in to the web UI of the camera, you need to enter this port number behind the IP address of the camera. The access format is the http://IP address of the camera: HTTP port.</p>
RTSP Port	<p>Specifies the port number for the Real Time Streaming Protocol (RTSP). The default settings are recommended.</p> <p>RTSP is used to transmit and control the audio and video, and it is responsible for the request and response between the server and the client.</p> <p>URL format: rtsp://IP address of the camera: RTSP port/bitrate type.</p> <p> TIP</p> <p>Profile0 means main stream and profile1 means sub-stream.</p>
Service Port	<p>Specifies the port number for the Open Network Video Interface Forum (ONVIF) protocol. The default settings are recommended.</p> <p>When the camera is added to the NVR through the ONVIF protocol, this port number is required.</p> <p>If the devices support this protocol, they can communicate with each other, which solves the compatibility problem of devices from different manufacturers (such as cameras, and NVR).</p>

4.2.3 Email

Overview



Navigate to **Configuration > Network > Email**.

This camera supports email alarms. If you want to receive alarm notifications through email, you need to configure the email alarm function first.

TCP/IP	Port	Email
Sender		
Sender		<input type="text"/>
Sender's Address		<input type="text"/>
SMTP Server		<input type="text"/>
SMTP Port	25	<input type="text"/>
<input type="checkbox"/>	Enable SSL	
<input type="checkbox"/>	Authentication	
User Name		<input type="text"/>
Password		<input type="text"/>
Confirm		<input type="text"/>
Receiver		
Receiver1		<input type="text"/>
Receiver1's Address		<input type="text"/>
Receiver2		<input type="text"/>
Receiver2's Address		<input type="text"/>
Receiver3		<input type="text"/>
Receiver3's Address		<input type="text"/>

Parameter description

Parameter	Description	
Sender	Sender	Specifies the sender's name. You can customize it as required.
	Sender's Address	Specifies the email account of the sender.
	SMTP Server	Specifies the SMTP server address and supports the IP address and domain address.

Parameter	Description
SMTP Port	Specifies the SMTP server port.
	 <p>After the encryption is enabled (SSL or TLS), the SMTP server port will be changed. The user needs to check and fill in the information by themselves.</p>
Enable SSL	Specifies the encryption mode for email transmission.
	Secure Sockets Layer (SSL) is a security protocol. It uses data encryption, identity verification and message integrity verification mechanisms to provide security guarantees for network data transmission
Server Authentication	Specifies whether to enable the server authentication of email.
	<p>After it is enabled, you need to enter the email account and password of the sender to log in to the email server.</p>  <p>If this function is disabled, it indicates that users anonymously log in to the SMTP server. This function can be disabled only when the SMTP server address supports sending anonymous emails.</p>
User Name	Specifies the email account of the sender.
Password	Specifies the password corresponding to the email account of the sender.
Confirm	
Receiver	Specifies the name of the receiver. You can customize it as required.
	Receiver's Address

Configure Email Alarm

Scenario: Assume that you have set up the monitoring network with the camera.

Requirement: After the camera detects a human, the alarm notification will be pushed through email to the specific receiver.

Solutions: Configure the **Human Alarm and Email** function to meet this requirement.

- SMTP server address: smtp.gmail.com
- SMTP service port: 465
- Sender email address: Tom@gmail.com
- Encryption mode: SSL
- Receiver email address: Jerry@gmail.com

Procedure:



Please ensure that the NVR has connected to the internet successfully before configuring the email alarm.

Step 1 Enable the SMTP service of the sender's email. **Gmail** is taken as an example here. (If it is enabled, skip this step.)

1. Open the browser, and log in to your **Gmail**. Click  (**Settings**) in the upper-right corner, and then click **See all settings**.

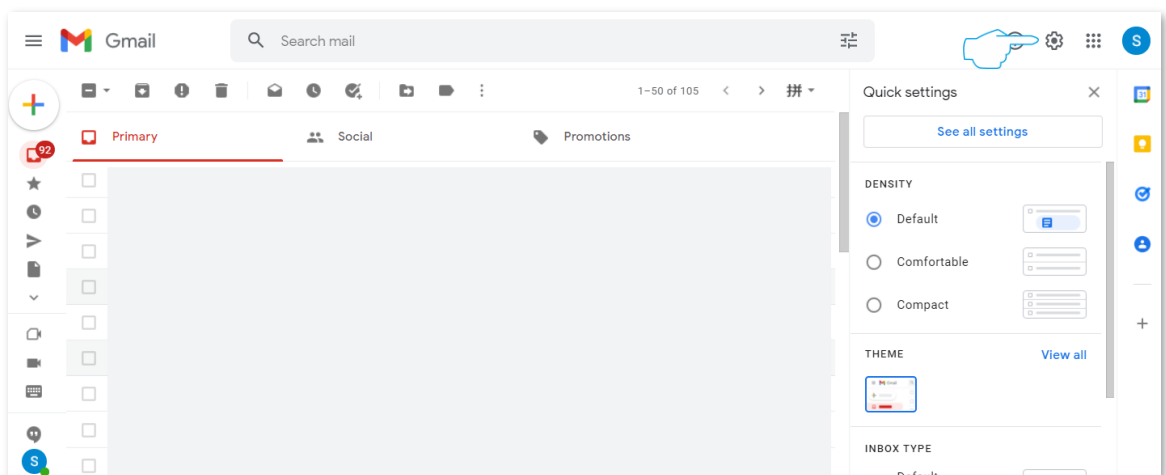

- Click **Forwarding and POP/IMAP** on the settings page. Find **IMAP access**, tick **Enable IMAP**, and click **Save Changes** at the bottom of the page.

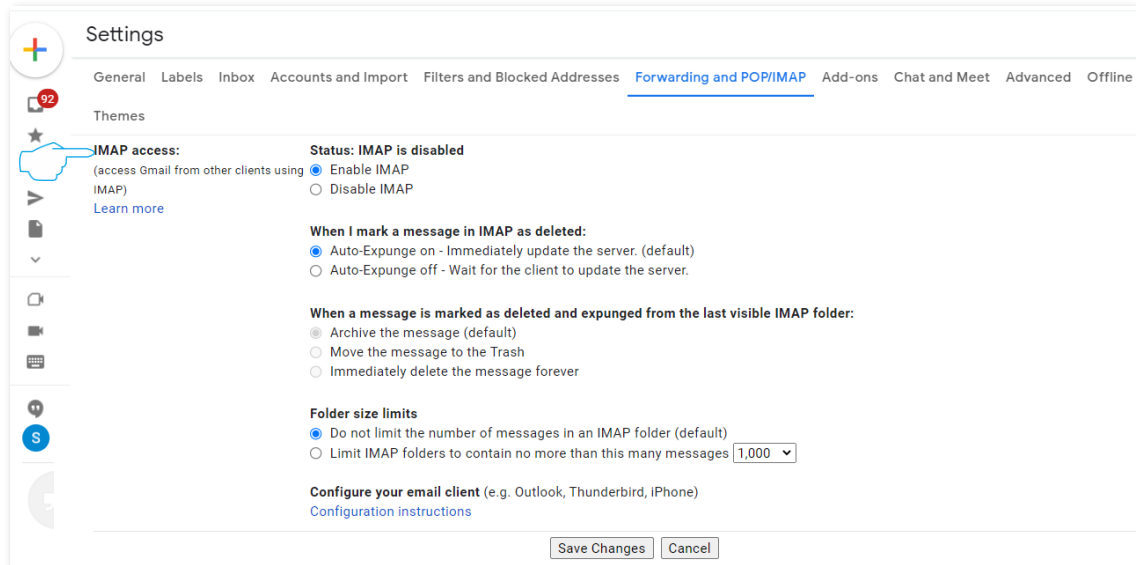

Step 2 Log in to the web UI of the camera to set alarm.

- [Log in to the web UI.](#)
- Enable the email alarm function.
 - Navigate to **Configuration > Alarm > Email**.
 - Set the name of the sender, which is **Tom** in this example. Enter the email address of the sender, which is **Tom@gmail.com** in this example.
 - Enter the SMTP server address, which is **smtp.gmail.com** in this example. Enter the SMTP server port, which is **465** in this example.
 - Tick **Enable SSL**.
 - Tick **Authentication**.
 - Enter the **User Name** in **Sender Email Account**, which is **Tom@gmail.com** in this example. Enter the **Password** of the Gmail of the sender and confirm the password.
 - Set the name of the receiver, which is **Jerry** in this example. Enter the email address of the receiver, which is **Jerry@gmail.com** in this example.
 - Click **Save**.

Sender	
Sender	Tom
Sender's Address	Tom@gmail.com
SMTP Server	
SMTP Port	465
<input checked="" type="checkbox"/> Enable SSL	
<input checked="" type="checkbox"/> Authentication	
User Name	Tom@gmail.com
Password	*****
Confirm	*****
Receiver	
Receiver1	Jerry
Receiver1's Address	Jerry@gmail.com
Receiver2	
Receiver2's Address	
Receiver3	
Receiver3's Address	

3. Set the human alarm.

- (1) Navigate to **Configuration > Basic Event > Motion Detection**.
- (2) Set **Alarm Mode**, which is **Human Alarm** in this example.
- (3) Tick **Send Email**.
- (4) Click **Save**.

Motion Detection	
Alarm Mode	Human Alarm
Linkage Method	
<input checked="" type="checkbox"/> Send Email	
<input type="checkbox"/> Light Alarm	
Interval	
Mail Interval	300 second
Motion Detection Interval	10 second
Save	

---End

After the setting completes, if the camera detects a human, the alarm notification will be pushed to the receiver through email.

4.3 Video/Audio

Navigate to **Configuration > Video/Audio > Video**.

The audio and video function enables you to adjust the video code parameters.

Video

Stream Type	<input type="text" value="Main Stream(Normal)"/>	▼
Video Type	<input type="text" value="Audio&Video Stream"/>	▼
Resolution	<input type="text" value="2304*1296"/>	▼
Bitrate Type	<input type="text" value="Variable"/>	▼
Video Quality	<input type="text" value="Highest"/>	▼
Frame Rate	<input type="text" value="25"/>	fps
Max. Bitrate	<input type="text" value="3072"/>	Kbps
Video Encoding	<input type="text" value="H.265"/>	▼
I Frame Interval	<input type="text" value="60"/>	

Parameter description

Parameter	Description
Stream Type	<p>Specifies the stream type of the camera.</p> <ul style="list-style-type: none"> – Main Stream: The stream has a large value and a high occupied bandwidth, which is applicable for large-screen monitoring and storage. – Sub Stream: The stream has a small value and a small occupied bandwidth, which is applicable for small-screen monitoring and network transmission.
Video Type	Specifies the multi-media type. Only the video code parameters can be adjusted.
Resolution	Specifies the number of pixels contained in a frame of an image. The higher the resolution, the clearer the image and the more obvious details.
Bitrate Type	<p>Specifies the bit rate control method of the video.</p> <ul style="list-style-type: none"> – Fixed: The fixed bit rate tries to encode according to the upper limit of the bit rate, and the bit rate will fluctuate up and down in the bit rate value, and will not change with the monitoring scene. – Variable: The bit rate will change with the monitoring scene. Adopt a high bit rate when the monitoring scene is moving or changing. The variable bit rate adopts a lower bit rate when the monitoring scene is static.
Video Quality	Specifies the quality level of the video. Please set it according to the actual situation. This parameter is available only when Bitrate Type is set to Variable .

Parameter	Description
Frame Rate	Specifies the number of video frames displayed per second. The higher the frame rate, the smoother the image.
Max. Bitrate	Specifies the size of the video data per unit time. The larger the bit rate, the better the picture quality.
Video Encoding	<p>Specifies the encoding standard of the NVR.</p> <ul style="list-style-type: none"> – H.264: A generation of highly compressed video codec standards after MPEG4, which improves compression efficiency under the same video quality. – H.265: A generation of video coding standards after H.264, which improves the bit stream, coding quality, and delay to optimize coding and save more bandwidth and capacity under the same video quality. <p> TIP</p> <p>Different cameras support different encoding standards. The actual page prevails.</p>
I Frame Interval	Specifies the number of the ordinary frame between two I frames (keyframe).

4.4 Image

4.4.1 Display Settings

Overview

Navigate to **Configuration > Image > Displays Settings**.

The display settings function enables you to set the day and night switching mode of the camera, and can also adjust the image parameters to improve the visual effect of the camera monitoring image.

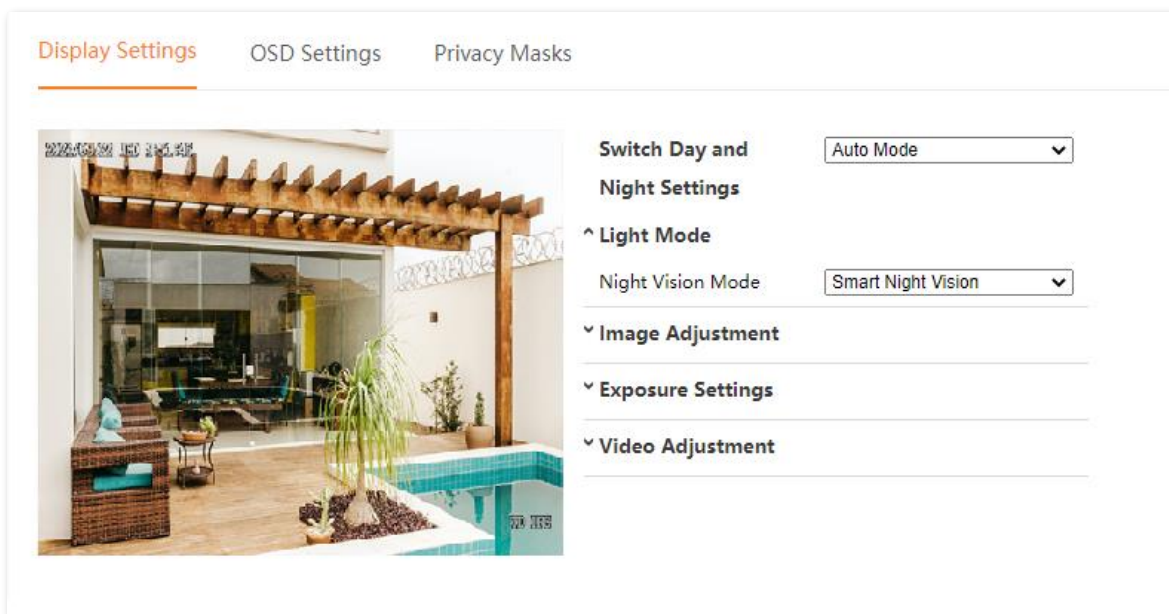

Parameter description

Parameter	Description	
Switch Day and Night Settings	Auto Mode	Specifies the camera switches to day mode or night mode according to the environment's brightness.
	Scheduled Mode	Specifies the camera switches to the corresponding mode according to the Day Start Time and Night Start Time you preset.
	Day Mode	Specifies the camera monitoring mode always is in day mode, and the monitoring image always is colorful.
	Night Mode	Specifies the camera monitoring mode always is night mode. After the infrared fill light of the camera is enabled, the monitoring image always is black and white.

Parameter		Description
Light Mode	Night Version Mode	<p>Specifies the monitoring image effect of the camera at night. It is applicable for the full-color version of the camera.</p> <ul style="list-style-type: none"> – Smart Night Vision: When the camera detects a moving object or a human figure, the white light fill light of the camera is enabled, and the monitoring image is in color; otherwise, the infrared fill light is enabled, and the monitoring image is black and white. – Full Color Night Vision: The white light fill light of the camera is enabled, and the monitoring image is always in color. – Black & White Night Vision: The camera infrared fill light is enabled, and the monitoring image is always black and white.
	Brightness	<p>Specifies the brightness of the image.</p> <p>The brightness value can be adjusted when the overall monitoring image is dark or bright. The larger the value, the brighter the image.</p>
Image Adjustment	Contrast	<p>Specifies the ratio of the lightest area to the darkest area in the image.</p> <p>The contrast value can be adjusted when the sense of layering in the monitoring image is poor, and the contrast between the white and black color of the image is insufficient. The larger the value, the greater the contrast between light and dark of the image, and the clearer the image.</p>
	Saturation	<p>Specifies the vividness of the colors in the image. The larger the value, the more vivid the image color.</p>
	Sharpness	<p>Specifies the sharpness of the edges of the image. The larger the value, the more obvious the edges of the image.</p>
Exposure Settings	Iris Mode	<p>Specifies the exposure mode of the camera.</p> <ul style="list-style-type: none"> – Auto: Adjust the exposure time of the sensitization device (such as CCD) according to the strength of the light. – Auto Gain: Automatically adjust the gain according to the manually adjusted exposure time to enable the camera to output standard images under different lighting conditions. – Auto Shutter: Automatically adjust the exposure time according to the manually adjusted gain to enable the camera to output standard images under different lighting conditions. – Manual: Manually adjust the exposure time and gain.
	Exposure Time	<p>Specifies the electronic shutter time of the camera.</p> <p>If the scene brightness, iris and gain are unchanged, the longer the exposure time, the higher the screen brightness.</p>

Parameter	Description
Gain	<p>Specifies the sensitivity of the camera. It is used to amplify the image signal after exposure.</p> <p>If the scene brightness, aperture, and exposure time are unchanged, the greater the gain, the higher the screen brightness.</p>
Mirror	<p>Specifies the monitoring image performs left and right exchange after the mirror is enabled.</p>
Rotate	<p>Specifies the monitoring image can be rotated. Please set it according to the actual situation.</p>
Video Adjustment	<p>Specifies the image format of the video. 50 Hz (PAL) and 60 Hz (NTSC) are supported.</p> <ul style="list-style-type: none"> – 50Hz: PAL format. It applies to such countries and regions as Mainland China, Hong Kong, UK. – 60Hz: NTSC standard. It applies to such countries and regions as Taiwan, the United States, Japan, and Canada.

Set Monitor Image Mode of the Camera

Assume that you want a colorful monitoring image of the camera during the day and night. You can modify the **Switch Day and Night Settings** of the cameras.

Procedure:

Step 1 [Log in to the web UI](#), and navigate to **Configuration > Image > Displays Settings**.

Step 2 Set **Switch Day and Night Settings**, which is **Day Mode** in this example.

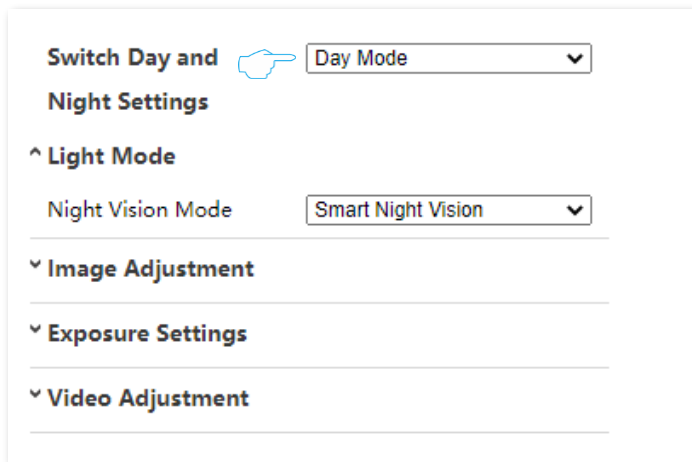

---End

After the setting completes, the monitoring images of the camera are colorful for the whole day.

4.4.2 OSD Settings

Overview

Navigate to **Configuration > Image > OSD Settings**.

On-Screen Display (OSD) refers to displaying the required information on the screen.

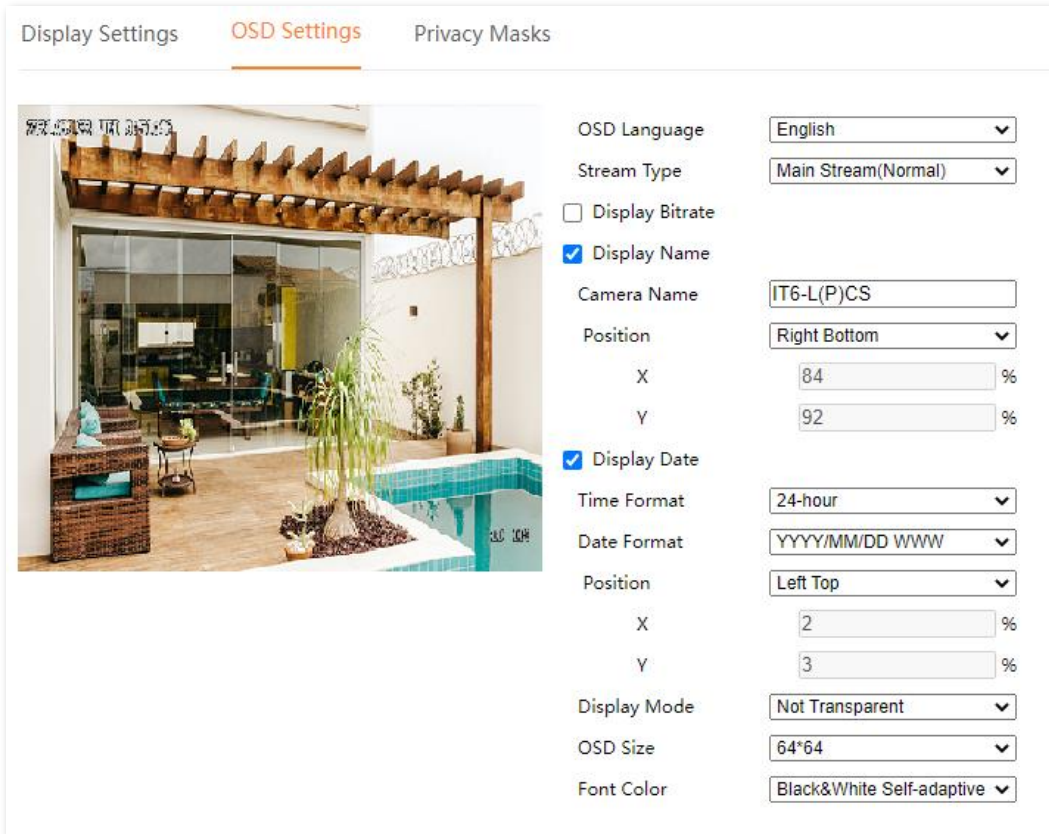

Parameter description

Parameter	Description
OSD Language	Specifies the language of time displayed in the camera monitoring image. Only Chinese and English are supported. Please set it according to the actual situation.
Stream Type	Specifies the stream type of the camera. Only the mainstream is supported for now.
Display Bitrate	Specifies the current real-time coding rate is displayed in the monitoring image after the Display Bitrate function is enabled.

Parameter	Description
	Specifies the channel name of the camera.
Camera Name	You are recommended to modify the camera name to the description of the installation position of the channel camera, so that you can quickly locate each camera by the camera name when managing multiple cameras.
Display Name	Position
	Specifies where the camera name is displayed. You can set it as required.
	X
	Specify the customized position where the channel names are displayed. Supported when the Position is Custom Design .
	Y
	You can customize the display position by the ratio of horizontal and vertical positions.
	Time Format
	Specifies the format of the system time display.
	Date Format
	Specifies the format of the system date display. Y means year, M means month, D means day, and W means week.
Display Date	Position
	Specifies the position where the time is displayed. You can set it as required.
	X
	Specify you can customize where the channel dates are displayed. Supported when the Position is Custom Design .
	Y
	You can customize the display position by the ratio of horizontal and vertical positions.
Display Mode	<ul style="list-style-type: none"> – Transparent: Specifies the OSD information is displayed by improving transparency. – Not Transparent: Specifies the display of OSD information is not transparent.
OSD Size	Specifies the font size of the OSD information display. It can be selected according to the actual situation.
Font Color	<ul style="list-style-type: none"> – Black & White Self-adaptive: Specifies the color of the OSD information display is white. – Custom: Specifies you can customize the color of the OSD information display.

Modify Camera Name

Assume that the camera is installed at door. You can modify the name of the channel to locate the camera easily.

Procedure:

- Step 1** [Log in to the web UI](#), and navigate to **Configuration > Image > OSD Settings**.
- Step 2** Tick the **Display Name**, and modify the **Camera Name**, which is **Doorway** in this example.
- Step 3** Click **Save** at the bottom of the page.

Display Settings **OSD Settings** Privacy Masks

OSD Language: English

Stream Type: Main Stream(Normal)

Display Bitrate

Display Name

Camera Name: Doorway

Position: Right Bottom

X: 89 %

Y: 92 %

Display Date

Time Format: 24-hour

Date Format: YYYY/MM/DD WWW

---End

4.4.3 Privacy Mask

Overview

Navigate to **Configuration > Image > Privacy Masks**.

You can set some areas in the monitoring image (such as the ATM password button area) as privacy areas here. After it is set as the privacy area, the area will not be displayed on the monitoring image to ensure the privacy of the area.

Use the mouse to draw a privacy area in the preview area on the left. The relevant parameters will be automatically filled in the right input box. You can modify or delete the privacy area as required.

X	Y	Width	Height	Operate
<input type="text"/>	<input type="text"/>	<input type="text"/>	<input type="text"/>	Modify Delete
<input type="text"/>	<input type="text"/>	<input type="text"/>	<input type="text"/>	Modify Delete
<input type="text"/>	<input type="text"/>	<input type="text"/>	<input type="text"/>	Modify Delete
<input type="text"/>	<input type="text"/>	<input type="text"/>	<input type="text"/>	Modify Delete

Parameter and button description

Parameter	Description
X	Specifies the horizontal coordinate position of the privacy area in the monitoring image. It can be manually modified after being filled in automatically.
Y	Specifies the vertical coordinate position of the privacy area in the monitoring image. It can be manually modified after being filled in automatically.
Width	Specifies the width of the privacy area. It can be manually modified after being automatically filled.
Height	Specifies the height of the privacy area. It can be manually modified after being filled in automatically.
Operation	<p>Specifies the operations you can perform for the privacy area:</p> <ul style="list-style-type: none"> After the horizontal coordinate, vertical coordinate, width or height of the privacy area are modified, click Modify to apply each parameter. Click Delete to delete the privacy area.

Draw Privacy Area

Assume that you want to hide some monitoring areas on the monitoring image.

Procedure:

Step 1 [Log in to the web UI](#), and navigate to **Configuration > Image > Privacy Masks**.

Step 2 Hold down the left mouse button to draw the private area on the left side of the preview area. Release the mouse after the privacy area is drawn.



You can adjust the size of the privacy area through the right-side input box. After each parameter is adjusted, click **Modify**.

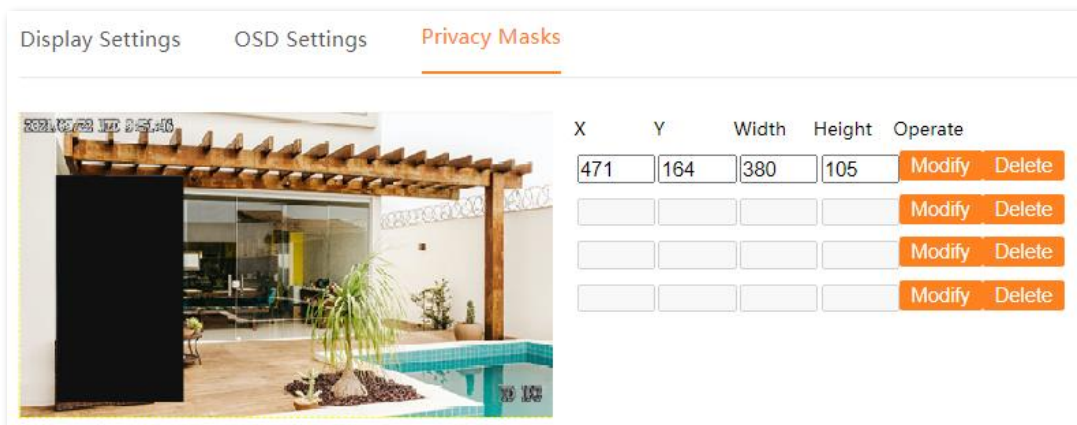

---End

After the setting completes, this privacy area is not displayed on the monitoring image.

4.5 Security

4.5.1 User

Overview

Navigate to **Configuration > Security > User**.

You can modify and add the login account of the camera here to prevent unauthorized users from entering the web UI of the camera to modify the settings, which will affect normal use.

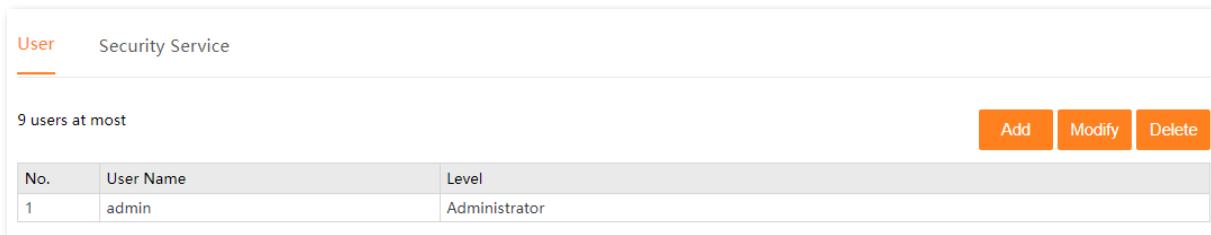

Parameter and button description

Parameter	Description
No.	Specifies the number of the login account.
Use Name	Specifies the user name allowed to log in to the web UI.
Level	<p>Specifies the type of login account.</p> <ul style="list-style-type: none"> – Administrator: After you log in to the camera with this account, you can add the login accounts, and view and modify all settings of the camera. – Operator/Ordinary User: After you log in to the camera with this account, you can only view settings and modify the login password of the current account.
Operation	<p>Specifies the operations you can perform for the login account:</p> <ul style="list-style-type: none"> – Click Add to add the login account. – Click Modify to modify such settings as the user name and password of this account. However, the user name and type of the administrator account cannot be changed. – Click Delete to delete the selected account. However, the user name and type of the administrator account cannot be deleted.

To add the login account, click **Add**.

Add user

User Name

Level

Password

Password Strength

Confirm

Parameter description

Parameter	Description
User Name	Specify the login user name and password of the web UI.
Password	
Level	Specifies the type of login account. You can select it according to the actual situation.
Password Strength	<p>The system can automatically identify the password strength. Setting high strength password is recommended.</p> <p> TIP</p> <p>A password containing multiple character combinations (such as digits, uppercase letters and lowercase letters) can enhance the strength of the password.</p>
Confirm	Specifies you need to re-enter the login password.

Add User

Assume that the administrator wants to add a login account for Tom.

Procedure:

Step 1 [Log in to the web UI](#), and navigate to **Configuration > Security > User**.

Step 2 Click **Add**.

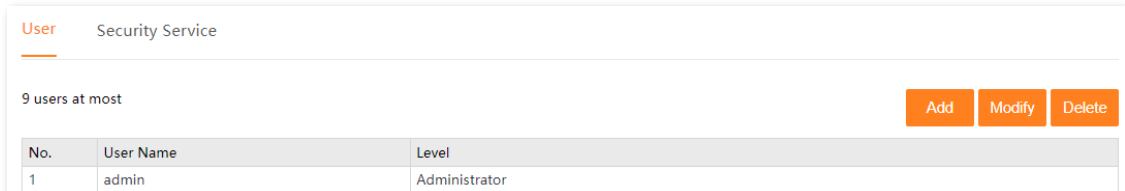

Step 3 Set the user name and password.

Step 4 Click **OK**.

Add user

User Name:

Level:

Password:

Password Strength:

Confirm:

OK Cancel

---End

After the setting completes, the account Tom can be used to log in to the web UI to view settings and modify the login password.

No.	User Name	Level
1	admin	Administrator
2	Tom	Operator

4.5.2 Security Service

Overview

Navigate to **Configuration > Security > Security Service**.

You can enable or disable RTSP authentication and ONVIF authentication here. After it is enabled:

- When a device accesses the camera through the RTSP protocol, the authentication information (user name and password) needs to be verified.
- When a device accesses the camera through the ONVIF protocol, the authentication information (user name and password) needs to be verified.

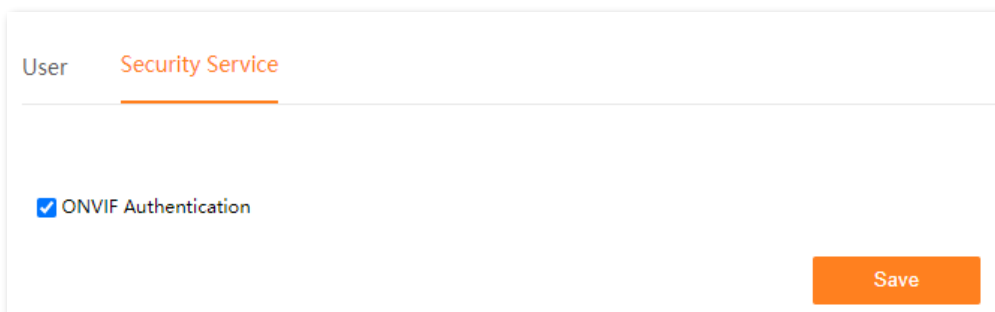

The screenshot shows a web interface for configuring security services. At the top, there is a breadcrumb trail: "User" followed by "Security Service" which is underlined in orange. Below this, there is a checkbox labeled "ONVIF Authentication" which is checked with a blue checkmark. In the bottom right corner, there is an orange "Save" button.

Disable ONVIF Authentication

Assume that you are using the NVR to add this camera through the ONVIF protocol, and you do not want to enter the user name and password of the camera. You can disable **ONVIF** to meet your requirement.

Procedure:

Step 1 [Log in to the web UI](#), and navigate to **Configuration > Security > Security Service**.

Step 2 Deselect **ONVIF Authentication**.

Step 3 Click **Save**.

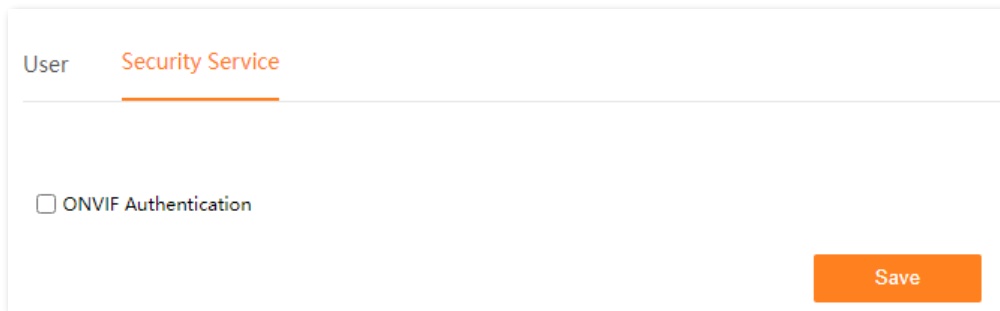

The screenshot shows a web interface for configuring security services. At the top, there is a breadcrumb trail: "User" followed by "Security Service" which is underlined in orange. Below this, there is a checkbox labeled "ONVIF Authentication" which is currently unchecked. In the bottom right corner of the configuration area, there is an orange button labeled "Save".

---End

After the setting completes, when the NVR adds this camera through the ONVIF protocol, the camera can be added normally without entering the login user name and password of the camera.

4.6 Basic Event

4.6.1 Overview

Navigate to **Configuration > Basic Event > Motion Detection**.

You can set alarm events and related information here. If an alarm is triggered, the system will alarm according to the linkage method you set.

Alarm Mode Motion Alarm ▼

Area Settings

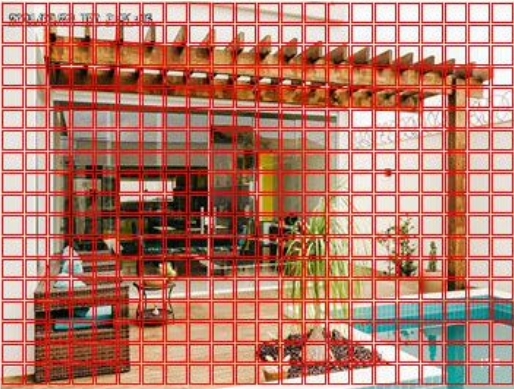

Select All Clear All

Sensitivity 50

Linkage Method

Send Email



Light Alarm

Interval

Mail Interval 300 second

Motion Detection Interval 10 second

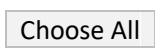
Parameter and button description

Parameter	Description
Alarm Mode	<p>Specifies the motion detection alarm you set.</p> <ul style="list-style-type: none"> – Alarm Off: Specifies the motion detection alarm function is disabled. – Motion Alarm: Specifies the system will alarm after the camera detects a target entering or leaving the alarm area. – Human Alarm: Specifies the system will alarm after the camera detects a human.
Area Settings	<p> Used to select all monitoring areas, left-click the square to select or invert the selection. Only Area Alarm is supported.</p>
	<p> Used to clear the selected monitoring area, and left-click the square to select or invert the selection. Only Area Alarm is supported.</p>
	<p>Sensitivity</p> <p>Specifies the detection sensitivity threshold that triggers the alarm. The larger the value, the easier it is to trigger an alarm. Only Area Alarm is supported.</p>
Linkage Method	<p>Send Email</p> <p>Specifies the alarm method after an alarm is triggered. Only sending email alarms is supported for now.</p>
	<p>Light Alarm</p> <p> TIP</p> <p>Specifies when an alarm is triggered, the camera flashes a fill light to the alarm. Applicable to the full-color version of the camera.</p> <p>If the fill light acts as a fill light and alarm function at the same time, the fill light function will be given priority.</p>
Interval	<p>Mail Interval</p> <p>Specifies the interval for the camera to send alarm emails after an alarm is detected.</p>
	<p>Motion Detection Interval</p> <p>Specifies the alarm detection interval after an alarm is detected.</p>

4.6.2 Configure Area Intrusion Alarm

Scenario: Assume that you have set up the monitoring network with the camera.

Requirement: The system will send an email to the specific receiver after the camera detects a target entering or leaving the alarm area.

Solutions: Configure the **Motion Alarm** and **Email** functions to meet this requirement. Assume that:

- SMTP server address: smtp.gamil.com
- SMTP service port: 465
- Sender email address: Tom@gmail.com
- Encryption mode: SSL
- Receiver email address: Jerry@gmail.com

Procedure:

Step 1 Configure area alarm.

1. [Log in to the web UI](#), and navigate to **Configuration > Basic Event > Motion Detection**.
2. Set **Alarm Mode**, which is **Motion Alarm** in this example.
3. Use the mouse to click the square to draw the alarm area (Red indicates the monitoring area, yellow indicates the non-monitoring area, click the square to select it) and set sensitivity as required. (The following figure is for reference only.)

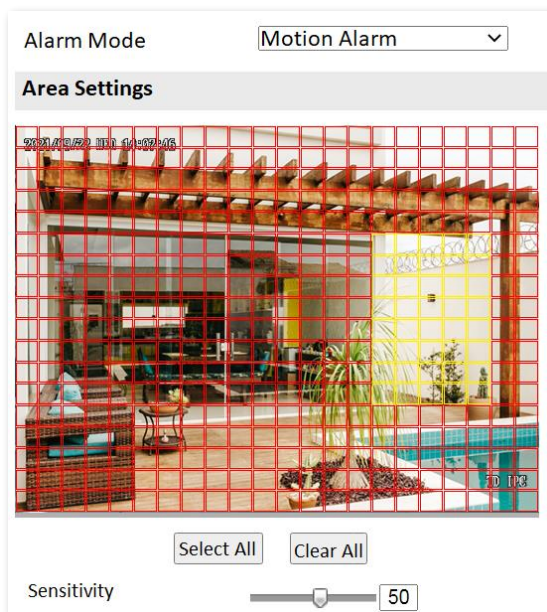

4. Select the alarm mode, which is **Send Email** in this example.
5. Click **Save**.

Linkage Method

Send Email

Light Alarm

Interval

Mail Interval second

Motion Detection Interval second

Save

Step 2 Configure the email alarm function. Refer to [Configure Email Alarm](#) for detailed steps.

TCP/IP Port **Email**

Sender

Sender

Sender's Address

SMTP Server

SMTP Port

Enable SSL

Authentication

User Name

Password

Confirm

Receiver

Receiver1

Receiver1's Address

Receiver2

Receiver2's Address

Receiver3

Receiver3's Address

---End

After the setting completes, the system will send an email to the specific receiver after the camera detects a target entering or leaving the alarm area.

4.6.3 Configure Human Detection Alarm

Scenario: Assume that you have set up the monitoring network with the camera.

Requirement: The system will send an email to the specific receiver after the camera detects human movement.

Solutions: Configure the **Human Alarm** and **Email** functions to meet this requirement. Assume that:

- SMTP server address: smtp.gamil.com
- SMTP service port: 465
- Sender email address: Tom@gmail.com
- Encryption mode: SSL
- Receiver email address: Jerry@gmail.com

Procedure:

Step 1 Configure human alarm.

1. [Log in to the web UI](#), and navigate to **Configuration > Basic Event > Motion Detection**.
2. Set **Alarm Mode**, which is **Motion Alarm** in this example.
3. Select the alarm mode, which is **Send Email** in this example.
4. Click **Save**.

Motion Detection

Alarm Mode: Human Alarm

Linkage Method

Send Email

Light Alarm

Interval

Mail Interval: 300 second

Motion Detection Interval: 10 second

Save

Step 2 Configure the email alarm function. Refer to [Configure Email Alarm](#) for detailed steps.

TCP/IP	Port	Email
Sender		
Sender		<input type="text" value="Tom"/>
Sender's Address		<input type="text" value="Tom@gmail.com"/>
SMTP Server		<input type="text" value="smtp.gmail.com"/>
SMTP Port		<input type="text" value="465"/>
<input type="checkbox"/> Enable SSL		
<input checked="" type="checkbox"/> Authentication		
User Name		<input type="text" value="Tom@gmail.com"/>
Password		<input type="password" value="....."/>
Confirm		<input type="password" value="....."/>
Receiver		
Receiver1		<input type="text" value="Jerry"/>
Receiver1's Address		<input type="text" value="Jerry@gamil.com"/>
Receiver2		<input type="text"/>
Receiver2's Address		<input type="text"/>
Receiver3		<input type="text"/>
Receiver3's Address		<input type="text"/>

---End

After the setting completes, the system will send an email to the specific receiver after the camera detects a human movement.

Appendixes

A.1 Configure your computer to obtain an IPv4 address automatically

Windows 10 is used as an example here.

Step 1 On the computer desktop, click **Start** , **Settings** , and choose **Network & Internet** .

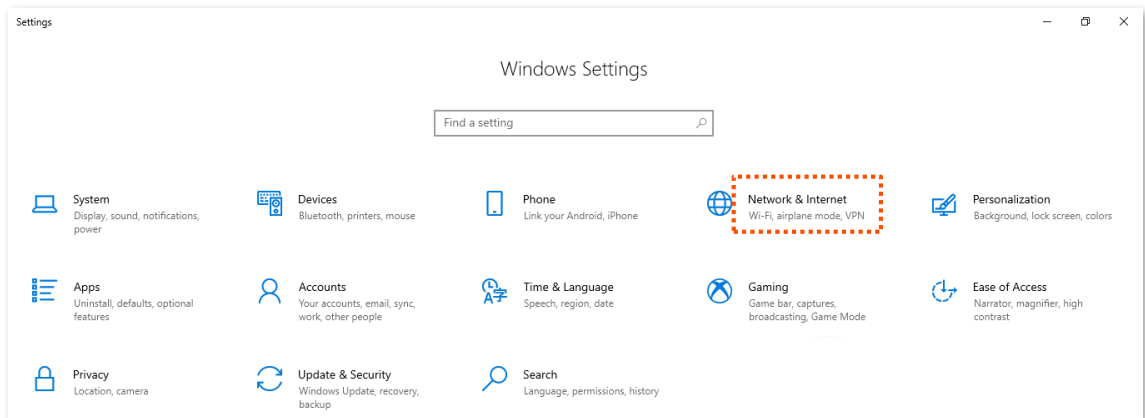

Step 2 Scroll down the mouse, and find **Network and Sharing Center**.

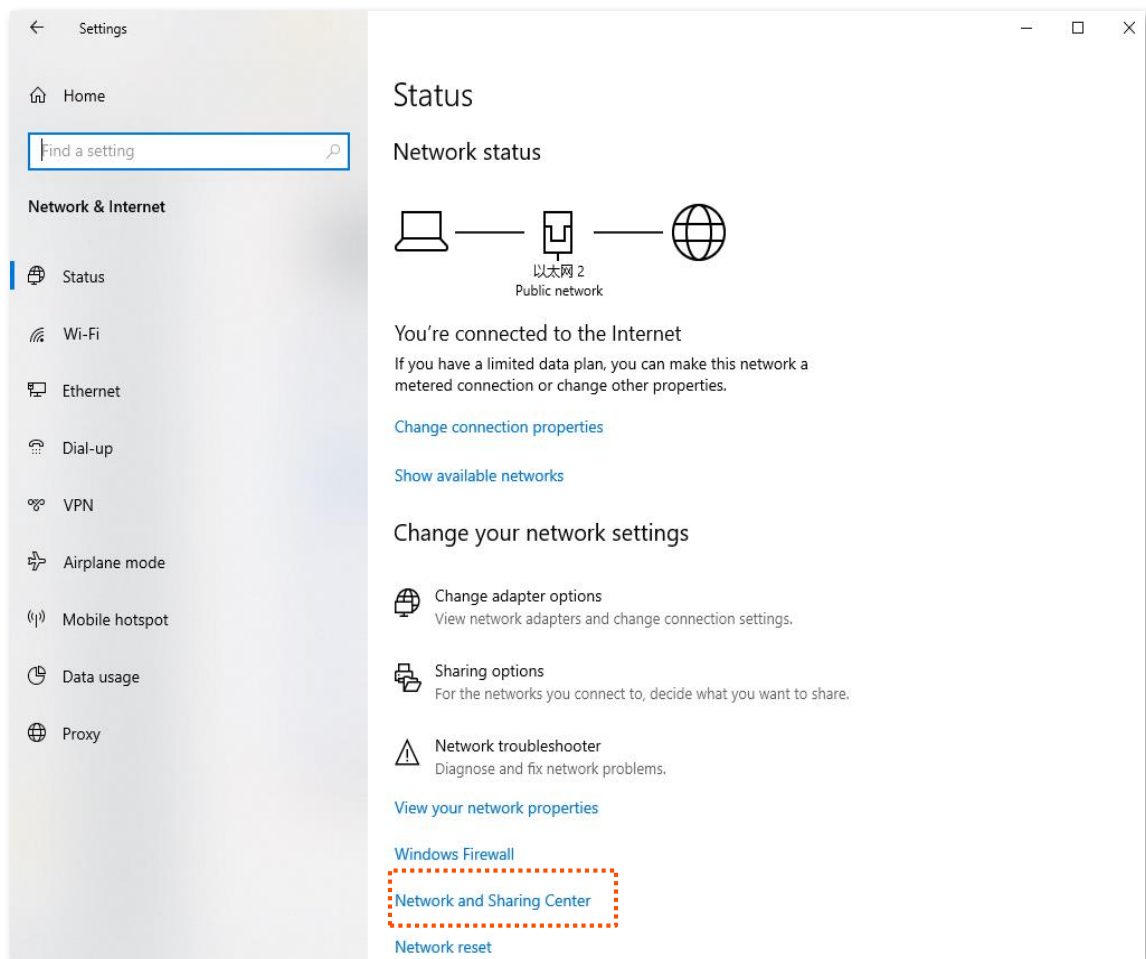

Step 3 Click **Ethernet**.

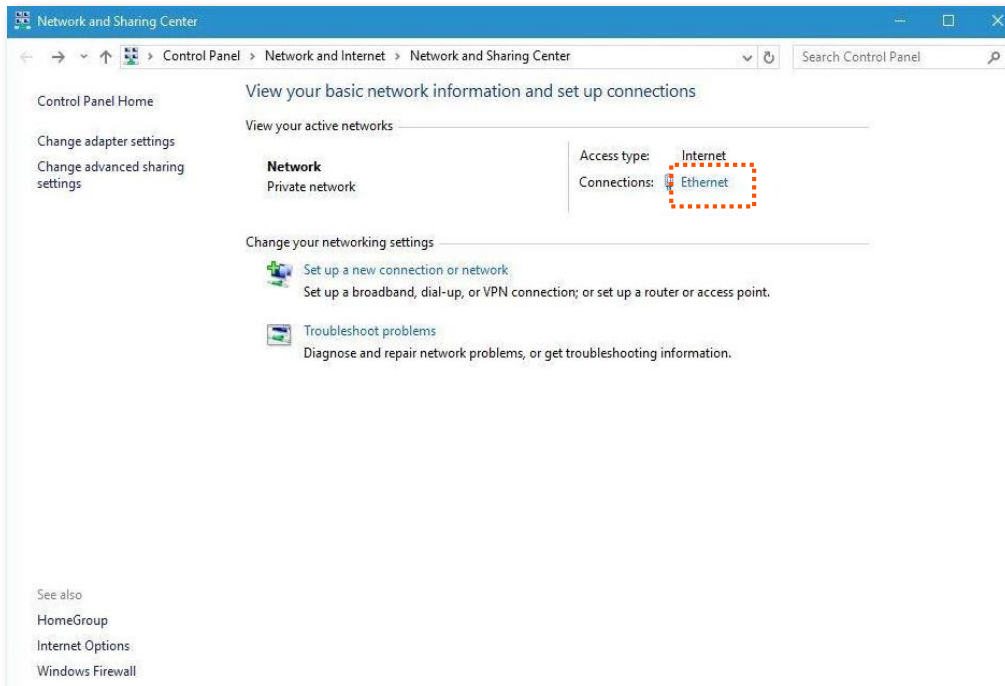

Step 4 Click **Properties**.

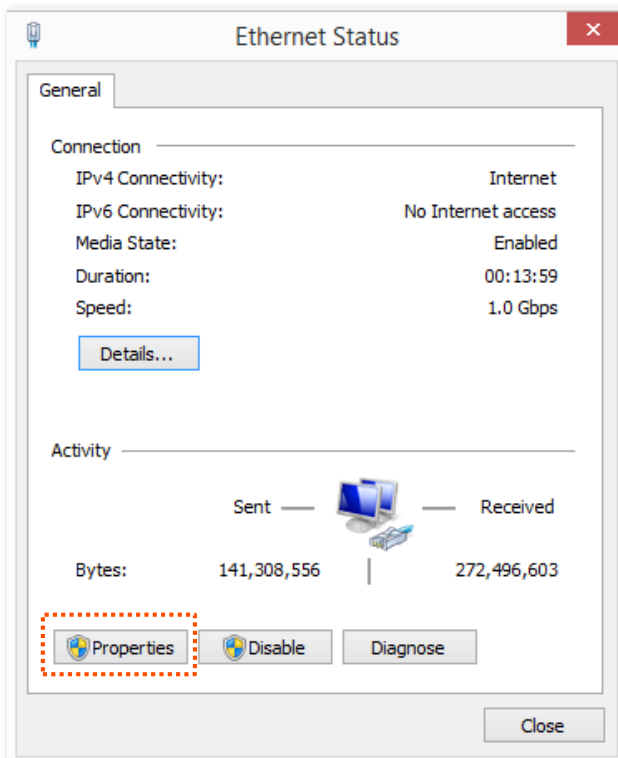

Step 5 Double-click **Internet Protocol Version 4 (TCP/IPv4)**.

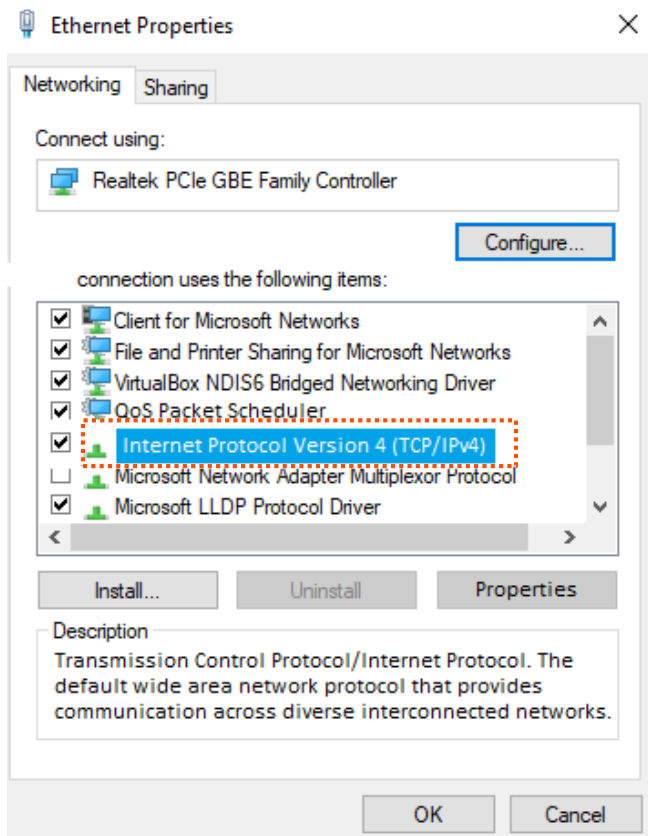

- Step 6** Select **Obtain an IP address automatically** and **Obtain DNS server address automatically**, and click **OK**.

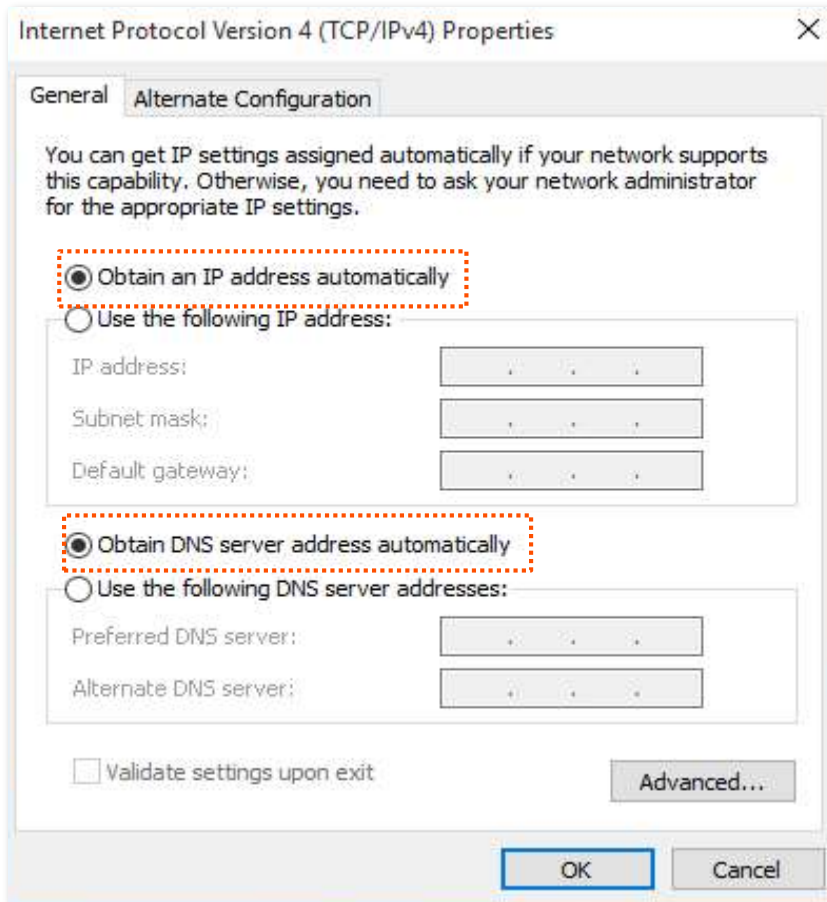

- Step 7** Click **OK** in the **Ethernet Properties** window.

---End

A.2 Default parameter values

The following table lists the default parameter values of the camera.

Parameter	Default Value
Login user name	admin
Login password	admin123456
IP address	192.168.1.203 If the NVR is in the network, the IP address of the camera may be automatically synchronized to the same network segment as the IP address of the NVR.
Subnet mask	255.255.255.0

A.3 Acronyms and Abbreviations

Acronym or Abbreviation	Full Spelling
ATM	Automated Teller Machine
CBR	Constant Bit Rate
CCD	Charge-coupled Device
DHCP	Dynamic Host Configuration Protocol
DNS	Domain Name System
GMT	Greenwich Mean Time
HDD	Hard Disk Drive
HTTP	HyperText Transfer Protocol
IMAP	Internet Message Access Protocol
IP	Internet Protocol
IPv4	Internet Protocol version 4
LAN	Local Area Network
MAC	Medium Access Control
NTP	Network Time Protocol
NTSC	National Television System Committee
NVR	Network Video Recorder
ONVIF	Open Network Video Interface Forum
OSD	On-screen Display
PAL	Phase Alteration Line
PoE	Power Over Ethernet
RTSP	Real Time Streaming Protocol
SMTP	Simple Mail Transfer Protocol
SSL	Secure Sockets Layer
TCP	Transmission Control Protocol

Acronym or Abbreviation	Full Spelling
TCP/IP	Transmission Control Protocol/Internet Protocol
TLS	Transport Layer Security
UDP	User Datagram Protocol
UI	User Interface
URL	Uniform Resource Locator
VBR	Variable Bit Rate